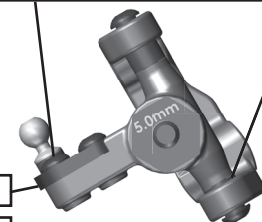

Front Suspension:

Ride Height: _____
Camber: _____
Toe: _____
Arm Type: _____
Tower Type: _____
Caster Block Insert: _____
Steering Block: _____
Bulkhead Type: _____
Kick-Up Angle: _____
Wheel Hex: _____
Notes: _____

Anti Roll Bar:
 White (0.8mm)
 Gray (0.9mm)
 Blue (1.0mm)
 Other: _____

Bump Steer Spacing: _____

Axle Height:
 +3
 +2
 +1
 0

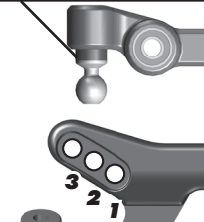
Ball Stud Spacing: _____

Steering Plate: _____
Steering Stop Spacing: _____

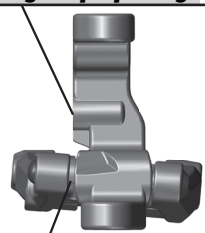

Caster Block Spacing: _____

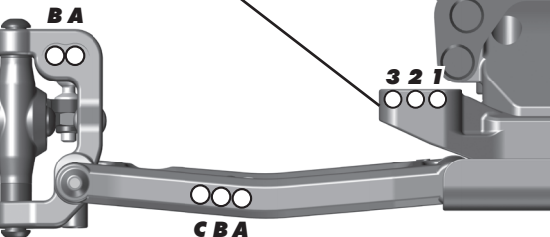
Ball Stud Spacing: _____

Rear Suspension:

Ride Height: _____
Camber: _____
Tower Type: _____
Wheel Hex: _____
CVA Bone Length: _____
CVA Pin Location: _____
Hub Spacing:
 Forward Middle Back
Shock Mounting Position:
 Front of Arm Rear of Arm
Notes: _____

Anti Roll Bar:
 White (1.2mm)
 Gray (1.3mm)
 Blue (1.4mm)
 Other: _____

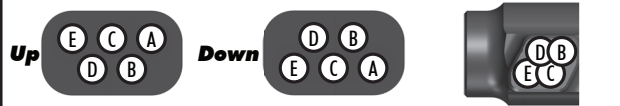
Rear Hub Link Setting:
 Plastic Hub Aluminum Hub Ball Stud Spacing: _____

C Mount Inserts: 1° 0.5°
 Aluminum Brass

D Mount Inserts: 1° 0.5°
 Aluminum Brass

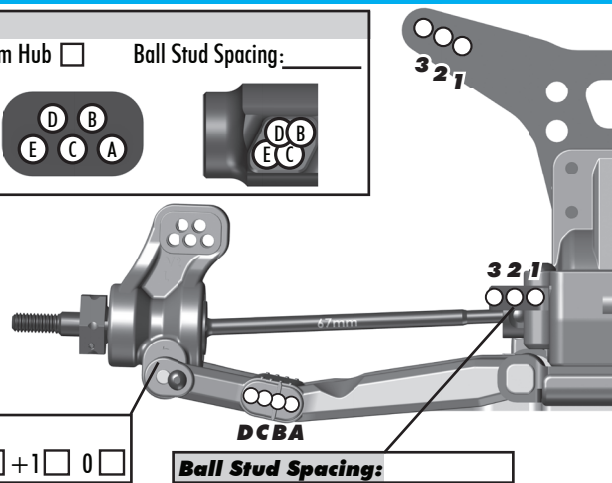

Hub Insert:
 +3 +2 +1 0

Ball Stud Spacing: _____

Electronics:

Radio: _____ **Servo:** _____
EPA: Throttle: _____ % Brake: _____ %
ESC: _____
ESC Settings: _____
Motor: _____
Wind: _____ **Timing:** _____
Pinion: _____ **Spur:** _____
Battery: _____
Battery Position: _____

Drivetrain:

Transmission: **Laydown:**
3 Gear: **Layback:**
4 Gear: **Stand Up:**
Differential: **Ball Diff:**
Height: _____ **Gear Diff:**
Notes: _____
Slipper Clutch:
Type: _____
of Pads: _____

Shocks:

	Front	Rear
Piston:	_____	_____
Fluid:	_____	_____
Spring:	_____	_____
Limiters:	_____	_____
Stroke:	_____	_____
Eyelet Length:	_____	_____
Cup Offset:	_____	_____
Notes:	_____	_____

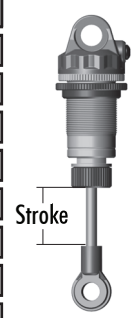

Track Info:

Size: Small Medium Large Extra Large
Surface: Dirt Carpet Astroturf Multi Surface
Traction: Low Medium High Very High
Moisture: Dry Damp Wet
Condition: Indoor Outdoor Dusty Hard Packed
 Bumpy Grooved Smooth Loamy
Temperature: Ambient: _____ Track: _____
Notes: _____

Tires:

Front Tires: _____
Front Compound: _____
Front Insert: _____
Rear Tires: _____
Rear Compound: _____
Rear Insert: _____
Wheel (F/R): _____
Notes: _____

Body, Wing, Weight:

Body: _____
Wing: _____
Wing Angle: 0° 3° 6°
Servo Weights:
 None Aluminum Steel Other
Electronic Weights:
 None Aluminum Steel Other
Total Vehicle Weight: _____

Vehicle Comments:

Notes: _____

