

Front Suspension:

Ride Height:
Camber:
Toe:
Arm Type:
Tower Type:
Caster Block Insert:
Steering Block:
Bulkhead Type:
Kick-Up Angle:
Wheel Hex:
Notes:

Anti Roll Bar:

White (0.8mm)

Gray (0.9mm)

Blue (1.0mm)

Other: _____

Bump Steer Spacing:

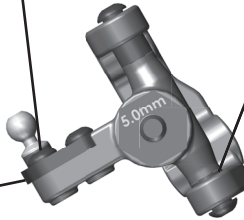

Axle Height:

+3

+2

+1

0

Ball Stud Spacing:

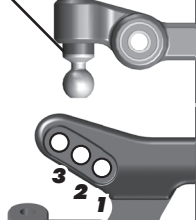

Steering Plate:

Steering Stop Spacing:

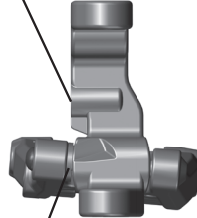

Caster Block Spacing:

Ball Stud Spacing:

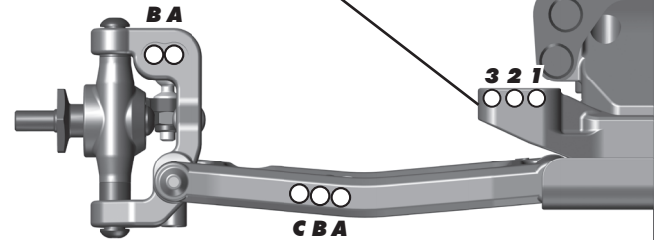

Rear Suspension:

Ride Height:
Camber:
Tower Type:
Wheel Hex:
CVA Bone Length:
CVA Pin Location:
Hub Spacing:
Forward <input type="checkbox"/> Middle <input type="checkbox"/> Back <input type="checkbox"/>
Shock Mounting Position:
Front of Arm <input type="checkbox"/> Rear of Arm <input type="checkbox"/>
Notes:

Anti Roll Bar:

White (1.2mm)



Gray (1.3mm)

Blue (1.4mm)

Other: _____

Rear Hub Link Setting:

Plastic Hub Aluminum Hub Ball Stud Spacing: _____

Up  **Down**  

C Mount Inserts: 1° 0.5°

Aluminum Brass

D Mount Inserts: 1° 0.5°

Aluminum Brass



Hub Insert:

+3 +2 +1 0

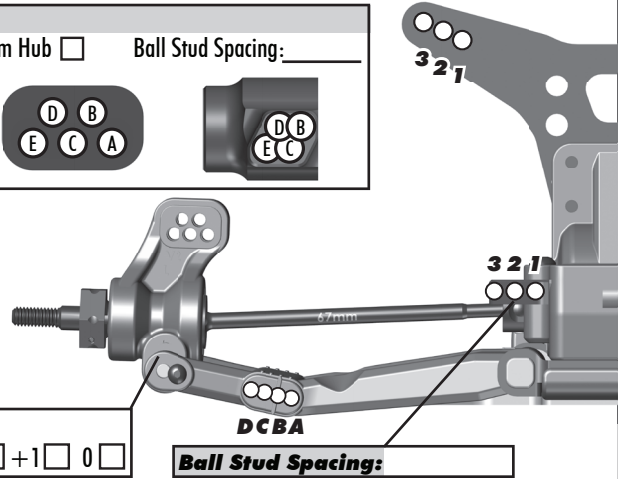

Electronics:

Radio:	Servo:
EPA: Throttle: _____ % Brake: _____ %	
ESC:	
ESC Settings:	
Motor:	
Wind:	Timing:
Pinion:	Spur:
Battery:	
Battery Position:	

Drivetrains:

Transmission:	Laydown: <input type="checkbox"/>
3 Gear: <input type="checkbox"/>	Layback: <input type="checkbox"/>
4 Gear: <input type="checkbox"/>	Stand Up: <input type="checkbox"/>
Differential:	Ball Diff: <input type="checkbox"/>
Height: _____	Gear Diff: <input type="checkbox"/>
Notes:	
Slipper Clutch:	
Type:	
# of Pads:	

Shocks:

	Front	Rear
Piston:		
Fluid:		
Spring:		
Limiters:		
Stroke:		
Eyelet Length:		
Cup Offset:		
Notes:		



Track Info:

Size: Small <input type="checkbox"/> Medium <input type="checkbox"/> Large <input type="checkbox"/> Extra Large <input type="checkbox"/>
Surface: Dirt <input type="checkbox"/> Carpet <input type="checkbox"/> Astroturf <input type="checkbox"/> Multi Surface <input type="checkbox"/>
Traction: Low <input type="checkbox"/> Medium <input type="checkbox"/> High <input type="checkbox"/> Very High <input type="checkbox"/>
Moisture: Dry <input type="checkbox"/> Damp <input type="checkbox"/> Wet <input type="checkbox"/>
Condition: Indoor <input type="checkbox"/> Outdoor <input type="checkbox"/> Dusty <input type="checkbox"/> Hard Packed <input type="checkbox"/>
Bumpy <input type="checkbox"/> Grooved <input type="checkbox"/> Smooth <input type="checkbox"/> Loamy <input type="checkbox"/>
Temperature: Ambient: _____ Track: _____
Notes:

Tires:

Front Tires:
Front Compound:
Front Insert:
Rear Tires:
Rear Compound:
Rear Insert:
Wheel (F/R):
Notes:

Body, Wing, Weight:

Body:
Wing:
Wing Angle: 0° <input type="checkbox"/> 3° <input type="checkbox"/> 6° <input type="checkbox"/>
Servo Weights:
None <input type="checkbox"/> Aluminum <input type="checkbox"/> Steel <input type="checkbox"/> Other <input type="checkbox"/>
Electronic Weights:
None <input type="checkbox"/> Aluminum <input type="checkbox"/> Steel <input type="checkbox"/> Other <input type="checkbox"/>
Total Vehicle Weight:

Vehicle Comments:

Notes: