

Front Suspension:

RESET

Ride Height: 25 mm

Camber: -1

Toe: +2 Out

Anti-Roll Bar

Size: 2.3 mm (Black)

Gap: 2 mm

Ackerman

1
2
3
4
5

Notes: 2mm Spacer Between Sway Bar Links; +2 Ackerman Plate With 1/2mm Under Ballstud; Short Chassis Brace; 5mm (+1) Hex;

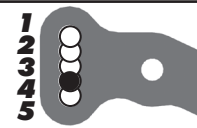
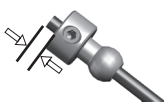

Caster Shim: 0.9 mm R / 2.9 mm F

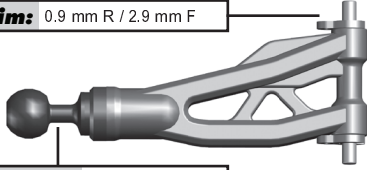

Upper Ball Type: #81068 Aluminum

Upper Ball Shim: 0

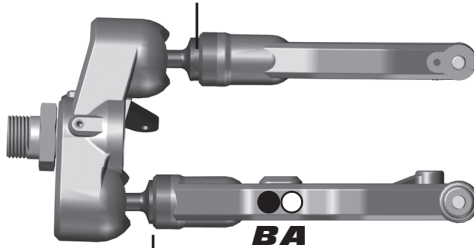

Lower Ball Shim: 0

Wheelbase Shim: 2 mm R / 0 mm F

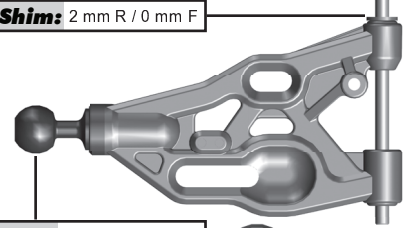

Lower Ball Type: #81068 Aluminum

Upper Arm Mount:

Arm Mount A:

Arm Mount B:



Rear Suspension:

Ride Height: 27 mm

Camber: -3

Anti-Roll Bar

Size: 2.7mm (Gray)

Gap: 0

Notes: Reverse Sway Bar Pivot Ball; Sway Bar Mount Moved Back 3mm In A-Arm; 5mm (+1) Hex; #81301 Short Chassis Brace; Plastic Hubs; Carbon Fiber Tower; Rock Guards;

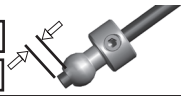

Hub Shim: 2.5 mm

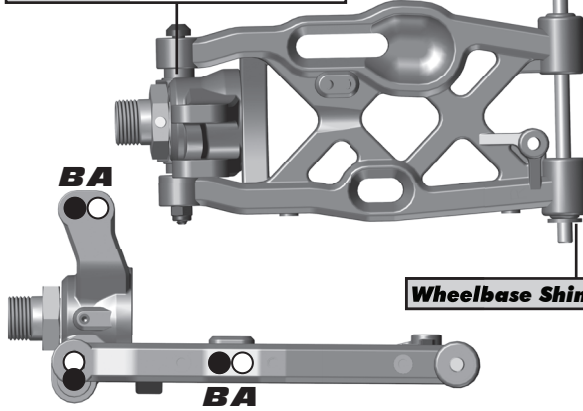

Arm Mount C:

Arm Mount D:

Wheelbase Shim: 0mm F / 1mm R

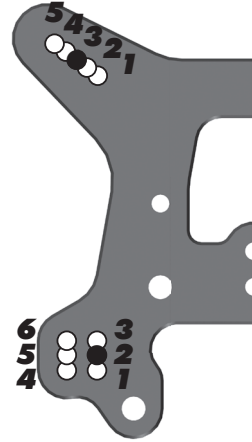

Electronics and Engine:

Radio:

Receiver Battery: Reedy 2100 mAh #315

Throttle Servo: Reedy RT2207A High Torque #27107

Steering Servo: Reedy RT2207A High Torque #27107

EPA: Throttle: 50 % Brake: 45 %

Brake Bias: 50/50 **D/R:** 100% %

Engine: O.S. B2101 **Temp:** 240

Muffler: O.S. 2090SC **Fuel:** 30%

Restrictor: 6 mm **Glow Plug:** P3

Differential Fluid:

Front: 7,000

Center: 10,000

Rear: 5,000

Notes: Filled 1mm above cross pins

Shocks:

	Front	Rear
Piston:	6 x 1.3 Flat	6 x 1.3 Flat
Fluid:	37.5 wt	32 wt
Spring:	Yellow (Cut 3/4 Coil)	Blue (Test Gray)
Stroke:	Flush With Threads	Flush With Threads
Free Length:	104 mm	120 mm
Notes:	Emulsion Shock	

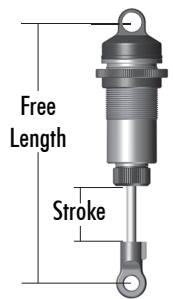

Clutch and Gearing:

Spur Gear: 46 **Bell:** 13

Shoes: 3 x Soft Aluminum #89134

Springs: 3 x 1.0

Notes:

Track Info:

Size: Small Medium Large Extra Large

Surface: Dirt Carpet Astroturf Multi Surface

Traction: Low Medium High Very High

Moisture: Dry Damp Wet

Condition: Indoor Outdoor Dusty Hard Packed Bumpy Grooved Smooth Loamy

Temperature: Ambient: 65 Track: 60

Notes:

Tires:

Front Tires:

Front Compound:

Front Insert:

Rear Tires:

Rear Compound:

Rear Insert:

Wheel (F/R): Team Associated 83mm

Notes:

Body, Wings:

Body: Team Associated Stock

Wing: Team Associated Stock

Wing Height: High: Low:

Gap to Tower: 28 mm

Weight:

Total Vehicle Weight: 3350g

Notes: #81274 Upper Titanium Screw Kit

Vehicle Comments:

Notes: Shave front of front a-arm 1mm to move a-arm forward & clearance for outdrive; CVAs