

XP2G

2.4GHz 2CH RADIO SYSTEM

XP3G

2.4GHz 3CH RADIO SYSTEM



No. 29215
No. 29216



Please read all instructions thoroughly before operating this device.

The contents are subject to change without prior notice due to product improvements and specification changes.

INSTRUCTION MANUAL

INTRODUCTION

Congratulations on your purchase of Team Associated's XP 2.4GHz Radio Control System. Designed using state-of-the-art wireless and advanced-programming technology, the XP 2.4GHz Radio Control System will advance and simplify control of your surface model while providing many years of enjoyment. Featuring spread spectrum and smart-frequency hopping systems, the XP 2.4GHz Radio Control System delivers precision control without risk of interference.

A variety of standard features developed to enhance user friendliness include Steering/Throttle trim adjustment, Steering/Throttle servo reversing, Throttle/Brake ATV, and Steering dual-rate adjustment.

Before installing and operating your new radio system, please take a few minutes to familiarize yourself with the various features of the system by reading this instruction manual thoroughly.

TABLE OF CONTENTS

INTRODUCTION >> 1	SETTING THE FAIL-SAFE POSITION >> 8 - 9
ADVANCED TECHNICAL FEATURES >> 1	FUNCTIONS >> 10
FEATURES >> 2	FCC INTERFERENCE STATEMENT >> 11
SYSTEM CONTENTS >> 2	USING CAUTION WHILE OPERATING >> 11
SPECIFICATIONS >> 2	ACCESSORIES >> 12
TRANSMITTER CONTROLS >> 3 - 4	SERVICE AND WARRANTY >> 15
INSTALLATION >> 5 - 6	TROUBLESHOOTING >> 15
BINDING PROCESS >> 7	

ADVANCED TECHNICAL FEATURES

iFHSS+ Data Mode

An improved data format and protocol provides faster and more reliable data transmission with reduced power consumption.

FHSS - Frequency Hopping Spread Spectrum

Advanced frequency-hopping program on the spread spectrum base increases safety and reliability with virtually interference-free communication.

SIBL - Security ID Binding Link

SIBL insures that the transmitter and receiver bind only to each other and prevents interference from other radios.

FSPC - Failsafe Programmable Individual Channel

If signal loss results, the system's fail-safe program returns each channel to its pre-programmed position.

FEATURES

TRANSMITTER

- Advanced 2.4GHz frequency-hopping spread spectrum technology*
- Steering/Throttle trim adjustment
- Steering/Throttle servo reversing
- Throttle/Brake ATV (Adjustable Travel Volume)
- Steering dual-rate adjustment
- LED battery voltage indicator
- Low battery alarm
- Integrated antenna
- Advanced iFHSS+ data mode

RECEIVER

- The TRS403SSi 2.4GHz 4Ch receiver's compact size and small footprint makes it easy to install in most electric or nitro powered vehicles.

*Your XP2G/XP3G transmitter is compatible with both TRS402SSi and TRS403SSi receivers. It is not compatible with the TRS401SSi receiver.

SYSTEM CONTENTS

Description	XP2G	XP3G
Item No	29215	29216
Transmitter	XP2G	XP3G
Receiver	TRS403SSi	
Servos	Not Included	
Accessories	Switch harness x 1; Receiver battery holder x1	

SPECIFICATIONS

Transmitter	XP2G	XP3G
Item No.	29215	29216
Configuration	Pistol Grip	
Encoder	2Ch	3Ch
Frequency	2.4GHz	
Modulation	GFSK (PPM)	
Current Drain	40mA@7.2V	60mA@7.2V
Transmission System	FHSS	
Servo Reverse	CH1~CH2	
Antenna Peak Gain	2dBi Typical	
Power Requirement	6AA/7.2V NiMH/2S LiPo	

Receiver	TRS403SSi
Item No	29214
Frequency (GHz)	2.4GHz
Channel	4CH
BEC	No
Modulation	PPM
Antenna Type	Single antenna w / gain
Battery Power	4.8~7.4V

XP2G
2.4GHz 2CH RADIO SYSTEM

XP3G
2.4GHz 3CH RADIO SYSTEM



- 1 Transmitter Antenna
- 2 Battery Level Indicator
- 3 Throttle ATV
- 4 Servo Reversing Switches
- 5 Steering Trim
- 6 Throttle Trim
- 7 Steering D/R (Dual Rates)

- 8 AUX Ch Button (XP3G only)
- 9 External Charging Jack
- 10 Binding SW
- 11 Steering Wheel
- 12 Power Switch
- 13 Throttle Trigger
- 14 Battery Cover

TRANSMITTER CONTROLS

1. **Battery Level Indicator:** Three LEDs indicate the voltage level of the battery. If the red LED flashes, please replace or recharge the batteries.
2. **Throttle ATV HI/LO:** Allows independent adjustment of the maximum throttle servo travel in each direction.
3. **Servo Reversing Switches:** Reverses a servo's direction of rotation. These switches are recessed so that they can't be moved accidentally.
4. **Steering Trim:** Allows small adjustments to the steering so that your model will travel straight when the steering wheel is in its neutral position.
5. **Throttle Trim:** Allows small adjustments to the throttle to shift the neutral position.
6. **Steering Dual-Rate (D/R):** Adjust this level + or - to add or reduce the amount of steering throw.
7. **AUX Button:** Provides an extra function for additional controls (XP3G only)
8. **External Charging Jack:** Used when charging NiMH rechargeable batteries.
9. **2.4GHz Binding SW:** The binding SW button is located on the top of the radio. Please refer to Page 7 for additional details regarding binding the radio and receiver.
10. **Steering Wheel:** Controls the vehicle's steering.
11. **Power Switch:** Slide to turn the transmitter ON or OFF.
12. **Throttle Trigger:** Pull or push to control the vehicle's movement forward or backward.
13. **Battery Cover:** Slide to remove the cover to remove or install batteries.

INSTALLATION

Transmitter batteries replacement / installation

- 1) Slide the battery cover in the direction shown to remove the cover
- 2) Install six (6) alkaline or rechargeable AA size batteries into the battery holder.
- 3) Slide the battery cover back into place making sure it is completely closed and secure
- 4) Turn the power ON. If the power indicator LED fails to light, check the batteries for insufficient contact or incorrect polarity.

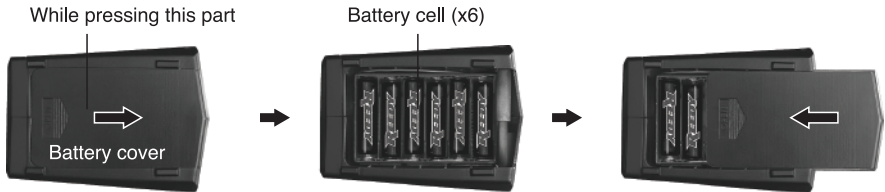

CHECK:

- a) Use only new alkaline cells all of the same brand
- b) Make certain that the contacts in the battery hold stay clean by using a pencil eraser to gently remove any corrosion or dirt that may accumulate on them. Clean the tabs each time new batteries are installed.
- c) If using a rechargeable battery pack, remove the battery holder and unplug it from the transmitter. Be sure to check polarity then plug the battery into the transmitter.
- d) When a NiMH rechargeable battery is installed in the transmitter, it can be charged using the external charging jack located on the transmitter.

⚠ CAUTION:

- a) Do not attempt to charge alkaline batteries. They may EXPLODE!
- b) When charging a rechargeable battery using the external charging jack, set the power switch to OFF. The charger plug must be the correct type (positive (+) inside and negative (-) outside, TAMIYA N-3U type or equivalent). The wrong type may burst causing personal injury and/or property damage.
- c) Always be sure the batteries are installed in the correct polarity order. If the batteries are installed incorrectly, damage to the transmitter may result.
- d) When the transmitter is not in use for more than one week, remove the batteries from the transmitter.

Receiver Battery Replacement/Installation

Insert four (4) fresh AA cells into the receiver battery holder making sure that the correct polarity order is observed. Insert the switch harness plug into the receiver socket marked BATT.

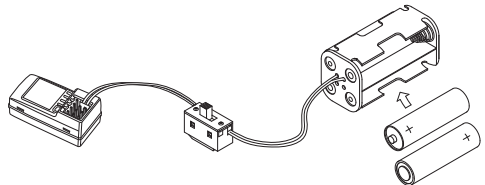

Radio installation

- 1) Connect the receiver, servo(s), and switch harness/battery pack as shown in the diagrams below.
- 2) Install the receiver in the location reserved for it inside the vehicle using double sided tape.
- 3) Route the receive antenna into the antenna tube making sure to prevent it from bending too tightly or to kink.
- 4) Never cut or shorten the antenna. Doing so will limit range and/or cause interference.

Electric Power Model Installation

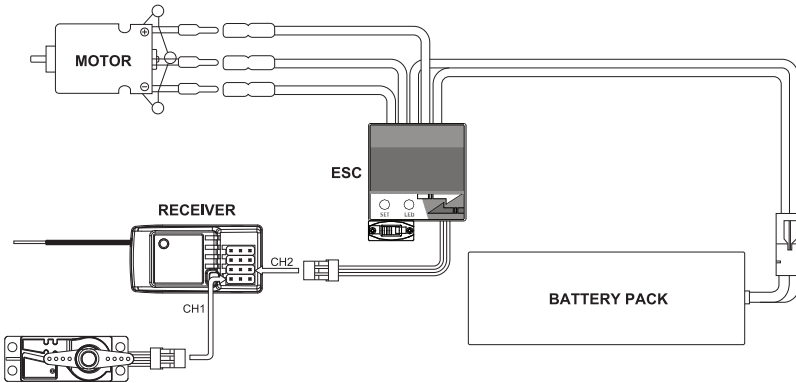

Gas Power Model Installation

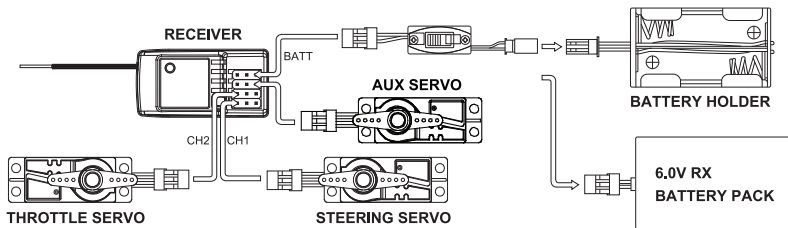

To prevent loss of radio range do not kink or cut the gray wire, do not bend or cut the metal tip, and do not bend or cut the white wire at the end of the metal tip.

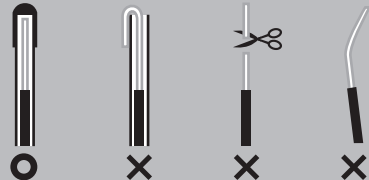



BINDING PROCESS

Before operating the vehicle, the transmitter and receiver must be manually bound. This binding will allow the receiver to accept the transmitter's signals and prevent interference from other transmitters. Manual binding is a one-time operation that will not have to be completed again. To manually bind the transmitter and receiver, follow the steps below:

1. Press and hold the BINDING SW button on the face of the transmitter while turning on the transmitter.
2. When the green/red LED flashes, release the BINDING SW button. The transmitter is now binding.
3. Press and hold the binding button on the receiver while turning on power to the receiver. The binding process will begin automatically indicated by the receiver LED flashing green/red.
4. Successful binding is confirmed when the binding LED on the transmitter stops blinking and remains green. The LED on the receiver will turn green. Once binding is complete, the system will automatically connect and the vehicle can now be controlled by the transmitter.

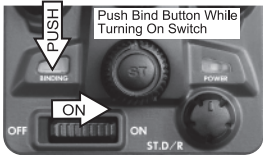
Note: The binding process may take between 3 and 10 seconds to execute. If binding fails, the LED on the receiver will turn red. Please turn off the power and repeat steps 1 through 4.

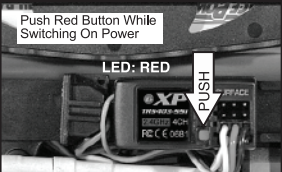
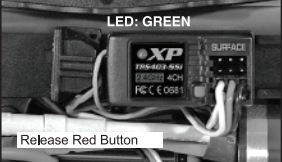
Step	TX Action	RX Action	LED
1		No action	-
2		No action	TX LED : Green/red flash
3	No action		RX LED : Greed/red flash
4	No action		TX LED: Green flash -> Solid green RX LED: Solid red -> Solid green

HOW TO SET THE FAIL-SAFE (F/S) POSITION

If signal loss results, the system's fail-safe program returns the steering and throttle to their pre-programmed positions. The default F/S position was automatically set to neutral during the binding process. However, the F/S positions for steering and throttle can be customized by completing the following steps:

Setting up the Failsafe (F/S) Function:

1. Turn on the transmitter followed by the receiver.
2. Press and hold the binding button on the receiver until the green light begins to flash (approximately 10 seconds).
3. While still pressing the binding button, move the throttle trigger and steering wheel to the desired F/S position.

 **CAUTION:** Always set the throttle trigger to the neutral or full brake position so that the vehicle will stop safely in the event of signal loss.
4. Release the binding button. The LED will turn solid red, and then two seconds later it will switch to solid green. The F/S position is now set.



To check that the F/S is working properly, move the throttle trigger to the full brake position and steering wheel to full lock. While holding them in this position, turn off the transmitter. The F/S function should return the throttle and steering to their F/S position.

If the F/S setup fails, retry steps 1 through 5. After successful setup, the vehicle can be operated safely.

It is recommended that the throttle F/S position be set to maximum brake in nitro powered cars. In electric cars, the throttle F/S position should be set to neutral. In all cars, it is recommended that the steering F/S position should be set to neutral.

View Fail-Safe Chart On Page 9

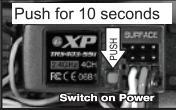
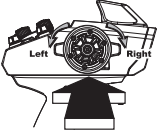
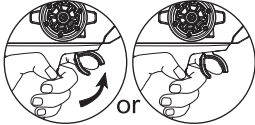
Setting up the Failsafe (F/S) Function:

Step	TX Action	RX Action	Check
1	Switch power ON	Switch power ON	TX LED : Solid green RX LED : Solid green
2	No action	 <p>Push for 10 seconds</p>	RX LED : Green flash
3	<p>1. Steering: Neutral</p>  <p>2. Throttle: Maximum brake or neutral</p> 	No action	RX LED : Green flash
4	Release second	 <p>Release first</p>	RX LED : Red solid -> Green solid

FUNCTIONS

1. Servo Reversing

It is sometimes necessary to reverse the output direction of the servo(s). The direction of rotation for each individual servo can be changed by flipping the reversing switch that corresponds to the channel number on the receiver where the servo is plugged in. Under normal circumstances, Ch 1 is steering and Ch 2 is throttle. Use the reverse switches as needed. Ch 3 is used for an auxiliary function and cannot be reversed.

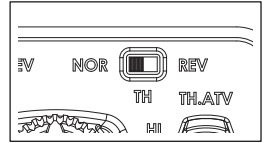

2. Steering Trim

• Neutral position trim

By turning the ST TRIM knob clockwise or counter-clockwise, the steering neutral can be adjusted as needed so that the vehicle runs straight.

HINT: When installing your servo, be sure that it is in its neutral position.

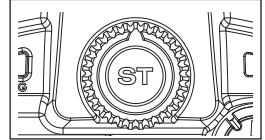

• Servo travel

Changing the steering trim will affect servo travel. After adjustments are made, please confirm that the desired steering travel is achieved.

HINT: If it takes most of the steering trim movement for the servo to reach the neutral position, re-position the servo horn/servo saver and make the necessary adjustments to your steering linkage.

3. Throttle Trim

• Neutral position trim

By turning the TH TRIM knob clockwise or counter-clockwise, the throttle neutral can be adjusted as needed.

HINT: When using an ESC, set the throttle trim to neutral and make adjustments to the ESC. Under normal operation, this will not require adjustment. On fuel powered models, set the trim to neutral and adjust the throttle linkage to the point at which the carburetor fully closes. See the engine instruction manual for details on setting up the throttle linkage.

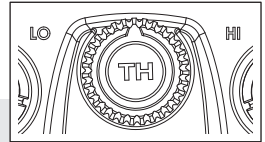

• Servo travel

Changing the throttle trim does not affect overall travel.

HINT: If it takes most of the throttle trim movement for the servo to reach the neutral position, re-position the servo horn and make the necessary adjustments to your linkage.

• Throttle ATV

Throttle ATV allows the servo travel to be independently adjusted on either side of neutral. This adjustment allows proper travel adjustment for throttle and brake in fuel powered vehicles.

HINT: For electric powered vehicles, the TH ATV knobs should be set to maximum. Maximum brake can be adjusted by reducing the TH ATV LO setting.

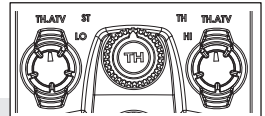

• Steering D/R

The steering dual-rate allows the user to make changes to the amount of steering servo travel. By changing the amount of travel in the steering servo, the user is able to adjust the overall steering of the vehicle to suit a particular driving style, preference, or changing track conditions.

HINT: Never adjust the servo travel beyond the mechanical limits of the vehicle. Doing so will place additional stress on the servo which could lead to premature failure.

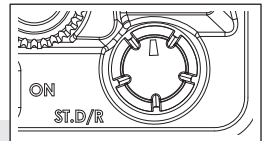

FCC INTERFERENCE STATEMENT

This equipment has been tested and found to comply with the limits for a Class B digital device, pursuant to Part 15 of the FCC Rules. These limits are designed to provide reasonable protection against harmful interference in a residential installation.

This equipment generates, uses and can radiate radio frequency energy and, if not installed and used in accordance with the instructions, may cause harmful interference to radio communications. However, there is no guarantee that interference will not occur in a particular installation. If this equipment does cause harmful interference to radio or television reception, which can be determined by turning the equipment off and on, the user is encouraged to try to correct the interference by one of the following measures.

- Reorient or relocate the receiving antenna.
- Increase the separation between the equipment and receiver.
- Connect the equipment into an outlet on a different circuit.

FCC Caution

To assure continued compliance, any changes or modifications not expressly approved by the party responsible for compliance could void the user's authority to operate this equipment. (Example - use only shielded interface cables when connecting to computer or peripheral devices). This device complies with Part 15 of the FCC Rules.

Operation is subject to the following two conditions:

(1) This device may not cause harmful interference, and (2) This device must accept any interference received, including interference that undesired operation may cause.

FCC RADIATION EXPOSURE STATEMENT

This equipment complies with FCC RF radiation exposure limits set forth for an uncontrolled environment. This equipment should be installed and operated with a minimum distance of 20 centimeters between the radiation and your body.

This transmitter must not be co-located or operating in conjunction with any other antenna or transmitter.

The antenna used for this transmitter must be installed to provide a separation distance of at least 20 cm from all persons and must not be co-located or operating in conjunction with any other antenna or transmitter.

USING CAUTION WHILE OPERATING

- Do not operate the model or use the radio in the rain, in the presence of lightning, or at night.
- Do not operate the model or use the radio if you have been drinking alcohol or are under the influence of any other substance that will affect your skills.
- Always confirm that the radio has sufficient battery power before operating.
- Keep out of reach of children
- Do not store the radio in temperatures below -10 °C (14°F) or above 40°C (104°F) or in a humid, dusty, or high vibration environments. Keep the radio away from direct sunlight.
- To prevent corrosion, remove the batteries if it will be stored for more than one week.

ACCESSORIES



29215 XP2G 2.4GHz Radio System
29216 XP3G 2.4GHz Radio System



29214 TRS403-SSI Receiver



29125 S1903MG Servo



29126 S2008MG High-Torque Servo



29133 XP DS1903 Digital Servo



29134 XP DS1903MG Digital Servo



29135 XP DS2008MG Digital High-Torque Servo



29128 C1016 Micro Servo

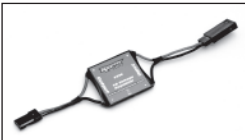

636 6.0V 5A Voltage Regulator

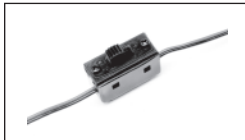

29115 Switch Harness (Fut J)



29117 4-AA Battery Harness



29166 XP DS1313 Digital Servo



29167 XP DS1015 Digital Servo



304 LiPo Pro RX Battery 1600mAh 7.4V Flat



305 LiFe Pro RX Battery 1300mAh 6.6V Flat



612 NiMH RX Battery 1600mAh 6.0V Hump



613 NiMH RX Battery 1600mAh 6.0V Flat



630 LiPo Pro RX Battery 1600mAh 7.4V 10C



631 LiPo RX Battery 2100mAh 7.4V



638 LiFe RX Battery 1700mAh 6.6V



604 526-S AC/DC 2S-6S LiPo/LiFe Charger



610 447-S AC/DC NiMH Peak Charger



302 AA Alkaline 1.5V (4)



303 AA 2700mAh NiMH 1.2V Rechargeable (4)

Declaration of Conformity

Annex IV of the R&TTE Directive 1999/5/EC

For the following equipment:

Product : Remote Controller for models
.....
Type Designation/Trademark : TX: XP2G ~ XP3G/ AE
.....
RX: TRS403-SS/ AE
.....
Manufacturer's Name : Thunder Tiger Corp. (Ningbo)
.....
Manufacturer's Address : 28 Jin-Feng Road, Liang Hui Industrial Park, Yuyao,
.....
Zhejiang 315400 China
.....

is herewith confirmed to comply with the requirements set out in R&TTE Directive 1999/5/EC of 9th March, 1999, Annex IV. For the evaluation of the compliance with this Directive, the following standards were applied:

EN 300 328 V1.7.1:2006-10
.....
EN 301 489-1 V1.9.2:2011-09
.....
EN 301 489-17 V2.1.1:2009-05
.....
EN 60065:2002/A1:2006/A11:2008/A2:2010/A12:2011
.....

Responsible for making this declaration is the :

Manufacturer Authorized representative established within the EU

Authorized representative established within the EU (if applicable):

Company Name :
.....
Company Address :
.....

Person responsible for making this declaration

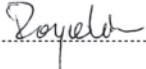
Name, Surname : Royce Lin 
.....
Position/Title : Vice President
.....

R.O.C
(Place)

2012-09-17
(Date)

SERVICE

Team Associated aspires to bring you the highest level of quality and service in the market. Our products are tested and raced around the world with the sole purpose of delivering state-of-the-art performance for enthusiasts of all levels. To view Team Associated's most up-to-date product information, please visit www.teamassociated.com or www.rc10.com. To purchase Team Associated products and accessories, please visit your favorite retail outlet. All Team Associated products have been carefully inspected prior to shipment. However, your Team Associated XP Series radio system is warranted to the original purchaser for one full year from the date of purchase against defects in material and workmanship. During this period, Team Associated will repair or replace, at its discretion, any defective components.

Equipment that has been mishandled, abused, improperly installed, or has been damaged due to a crash or other cause is not covered under warranty. Equipment that has been repaired or modified by an unauthorized person or agency is also void of warranty.

This warranty is for the original product only. Associated Electrics, Inc. shall not be liable for any loss or damages, whether direct or indirect, incidental or consequential, or from any special situation, arising from the use, misuse, or abuse of this product. This limited warranty gives you specific rights. You may also have other rights, which vary from state to state.

Do not return the equipment to the point of purchase as they are not authorized to honor warranty claims or perform service. Remove the radio equipment in question from the model and remove all accessories. Do not send the entire vehicle and be sure the item(s) is packed in a strong cardboard box with plenty of soft packaging material. We recommend using a shipper's tracking service. Team Associated is not responsible for any items lost in transit.

Please return the items to Team Associated, Attn: Service Department, and include the following:

1. Your full name, mailing address, telephone number, and email address.
2. A note, inside the box, describing in detail the problems you are having or the service you are requesting.
3. A copy of the original sales receipt showing the purchase date.

Once received, warranty service will be performed and items returned promptly. You will be notified by telephone when an item does not fall under the terms of the warranty and service charges are required. Please see www.rc10.com/rc/replacex for details regarding Team Associated's XP Lifetime Product Replacement Policy.

TROUBLE SHOOTING

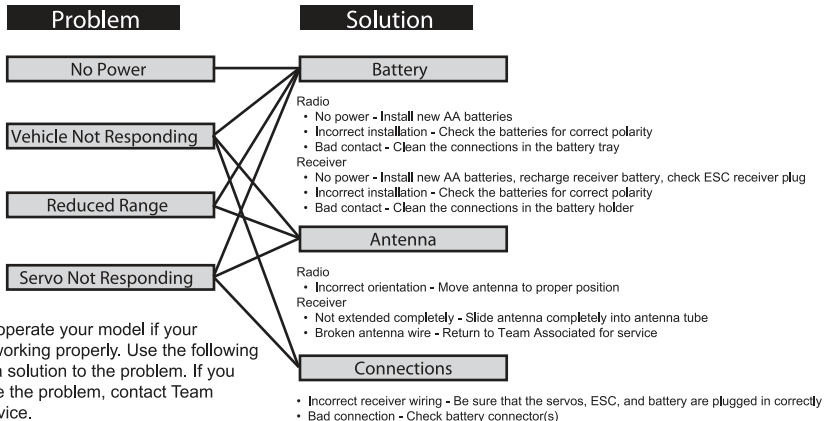

Do not attempt to operate your model if your transmitter is not working properly. Use the following guidelines to find a solution to the problem. If you are unable to solve the problem, contact Team Associated for service.