

RC 12i

**PRELIMINARY
ASSEMBLY AND OPERATING INSTRUCTIONS**

WARNING

Ni-Cd batteries are susceptible to damage when overcharged at a high rate, and can release caustic chemicals if the overcharge is severe. Read the battery charging instructions in this manual before attempting to run your car.

PLEASE READ THIS

Before you attempt to run your car.

You're probably anxious to run your new car, but you need to do the following first.

STEP 1 – INSTALL BATTERIES IN TRANSMITTER. The radio transmitter is supplied without batteries. Open the back of the transmitter case and install the correct number of cells. Most transmitters use seven "AA" size penlight cells. If you have purchased a rechargeable pack for your transmitter it should be slow charged overnight before use.

STEP 2 – TEST CHARGE YOUR CAR BATTERY. Disconnect the 3-pin battery connector on the right side of the car. Connect your fast charge cord (or a charger designed for R/C cars) to the battery pack. A 12 volt automobile battery should be used as a charging source. Connect the RED clip to the POSITIVE (+) terminal, and the BLACK clip lead to the NEGATIVE (-) terminal of the automobile battery. This first charge should be for FIVE MINUTES ONLY. It is normal for the charge cord to become warm while charging.

STEP 3 – TEST THE RADIO. When the five minute charge is complete unplug the charging cord and reconnect the battery to the radio tray plug. Turn on the transmitter first and then the receiver. Hold the rear wheels of the car off the ground and test steering and throttle action. Having determined that the steering and throttle are working properly, you can drive the car.

STEP 4 – RUN THE CAR. Pick a safe area away from automobile traffic, dirt, and water puddles. With this initial five minute charge, the car will operate for about two to four minutes. Run the car until it slows down noticeably, or until the radio stops functioning. When you stop operating the car, turn off the receiver switch first, then the transmitter. Unplug the battery connector to prepare for recharge.

STEP 5 – FULL BATTERY CHARGE. The fast charge cord supplied with your car will charge the battery in 15 minutes. DO NOT attempt to fast charge longer than 15 minutes, as permanent battery damage can occur. DO NOT continue charging if the battery becomes excessively warm.

STEP 6 – READ THE OPERATING INSTRUCTIONS. To get the best performance from your car read Section III of this manual for tips on battery charging, driving, tuning, and modifying your car.

[This sectional divider page was left blank in original manual]

SECTION 1

ASSEMBLY INSTRUCTIONS - RC12i Rolling Chassis

This section applies to the assembly of all kit forms of the RC12i. Refer to Section 2 for final assembly and radio installation.

Larger parts not in bags:

Chassis plate
Radio tray
Damper plate
Chassis rib
Antenna tube
Wing mount piano wire
Servo tape
Bumper
Front and rear wheels/tires

(Note: Kits numbered 4010 and higher contain additional parts. Refer to Section 2)

INTRODUCTION

Welcome to the world of radio control model car racing. We thank you for buying our car, and we feel certain that you will get great satisfaction and fun from it.

1/12 scale electric R/C cars are one of the newest developments in the sport of model car racing, following in the footsteps of 1/8 scale gas powered cars. Electric cars offer the challenge and excitement of gas cars together with the silence, cleanliness, and convenience inherent to electric power. Your RC12i is a descendent of the RC12E, the most successful and popular 1/12 race car ever produced. The 12i combines this heritage with the latest advances in suspension, steering geometry, dampening, and weight reduction techniques. You are about to build one of the highest performance 1/12 scale cars in the world.

To insure maximum performance from your car we recommend that you read and follow the assembly instructions carefully. Your task will be made easier and you might pick up a few speed secrets along the way.

GENERAL INFORMATION

PARTS LIST

Small parts bags, numbered as shown:

- 4/ 1. Front end
- 4/ 2. Rear end
- 4/ 3. Front end linkage
- 4/ 4. Wheel parts
- 4/ 5. Body mounts
- 4/ 6. Radio tray parts
- 4/ 7 or 4/12. Differential or rear axle

To eliminate confusion the small parts should be left in their individual bags until you are ready to assemble them on the car. This is very important because there are mounting screws, washers, etc., that are very slightly in dimension but must be used in the correct place.

Some of the plastic parts may have a small amount of flash. In most cases this will not interfere with the function of the part, but you may wish to remove the flash for cosmetic reasons.

The small protrusion left by the gate in the molding process can be sliced off with a sharp knife. Flash along the edge of a part can be removed by scraping with a sharp hobby knife, using a **light**, rapid, back-and-forth motion while holding the blade perpendicular to the edge of the plastic so that it has no tendency to "dig in". You can also use emery cloth to remove flash from an edge. Do not attempt to carve or slice the flash from the part.

Flash on flat surfaces can be removed by wiping the part lightly on a piece of emery paper that is laying on a flat table. This method leaves a sanded finish that will tend to get dirty easily, so don't use it on surfaces that show.

8-32 phillips flathead aluminum screws are used to hold the nylon parts

to the chassis. These are aircraft-grade screws with 100 degree countersink heads. The screws form their own threads as they are run into the hole, and the resulting attachment is firm and self-locking. The screws can be removed and replaced many times without any loss of locking action.

It is important to start the screws pointing straight into the hole. Use a new, good quality, medium-sized phillips screwdriver to run the screws in. DON'T RUSH... it's possible to damage the screwhead socket if you don't keep the screwdriver tight against the screw while driving it in. DO NOT use a power screwdriver for assembly.

TOOLS

Tools required for kit assembly:

ruler (to aid in parts identification)
pliers
small phillips screwdriver
medium phillips screwdriver (#SP76)
cyanoacrylic glue (Super Glue, Hot Stuff, Eastman 910, or equiv)
medium grit emery cloth
hobby knife

3/32" and .050" Allen key wrenches are supplied with this kit to fit all the Allen cap screws and setscrews on the car. However, a 3/32" Allen wrench with a screwdriver handle (Assoc. #SP73) will make tire and motor changes much easier and faster. A penknife with a small blade is useful to remove and replace the front wheel "E"-clips. A gear puller (Assoc. #3810) is needed if you plan to experiment with different gear ratios.

CHASSIS PREPARATION

Locate the chassis plate and the chassis rib: a 1/2" wide strip of black, gray, or white plastic 1/16" thick and approximately 6-1/2" long. The rib is not shown in the parts identification pictures, but does appear in the assembly photos (see Fig 5).

Lay the chassis right side up, ie. countersink side down, on a surface that you know is flat. Glass-topped tables, countertops, etc., are usually fairly

flat. Use two or three layers of newspaper to protect the surface if necessary. Position the rib on the chassis as shown in Fig 5 with the rib starting 1/2" from the front edge of the chassis. Outline the rib on the chassis with a pencil. Using medium grit emery cloth, lightly sand the **shiny** side of the rib. Also sand the chassis surface within the outlined area. Run a **small** zig-zag bead of super glue down the sanded side of the rib and mount the rib to the chassis, pressing the rib firmly to the chassis until the glue sets. Wipe off the excess glue with a paper towel. The glue has a tendency to stick fingers together, so be careful!

FRONT END

Contents of Front end bag (#4/ 1)

1 - Suspension arm, left	(#3210)
1 - Suspension arm, right	(#3210)
2 - Steering blocks	(#4112)
2 - Stub axles	(#4122)
2 - Kingpins	(#3212)
4 - "C"-clips	(#4124)
10 - "E"-clips	(#3214)
2 - 8-32x1/2 f.h. alum. screws	(#3324)
2 - 8-32x7/8 f.h. alum. screws	(#4181)
2 - 8-32 nylon locknuts	(#4185)
1 - Front end cross brace	(#4120)

Open the front end bag and locate the two suspension arms, two 1/2" aluminum screws, and two 7/8" aluminum screws. Mount the suspension arms over the second and third holes back from the front of the chassis (see Fig 6). Use the longer 7/8 screws in the front holes.

Locate the two steering blocks, two kingpins, and two stub axles. The stub axles are slightly shorter than the kingpins, and are made of harder steel, so don't mix them up. Insert the stub axles (Fig 7) into the steering blocks from the **inside** of the blocks (the side with the square hole). The fit will be tight so start the axles in by hand and then drive them part way through by tapping on the axle with the plastic handle of a screwdriver. Put a "C"-clip (smaller than the "E"-clip) on the inside end of the axle and drive it the rest of the way through until the "C"-clip is tight against the bottom of the square

hole. (If you accidentally used an "E"-clip it will not fit in the square hole!)

Run a kingpin completely in and out of the kingpin hole of each steering block several times. This will remove burrs and tight spots, and allow the block to swivel freely on the pin. Wipe the top and bottom surfaces of the blocks with emery paper to remove any flash. Press the kingpins into the underside of the suspension arms until they just begin to show in the gap (see Fig 8). Position the steering blocks in the gap with the angled arm on the block pointing to the back of the car. Align the holes and press the kingpin through the blocks and upper portion of the suspension arms. Place "E"-clips on both ends of the kingpins. Check that the steering blocks swivel freely.

Install the front end cross brace using two 8-32 nylon locknuts (see Fig 8). At this point your car should appear as in Fig 9.

REAR END

Contents of the rear end bag (#4/ 2)

- 1 - Rear axle bracket, right (#4141)
- 1 - Rear axle bracket, left (#4141)
- 1 - Camlock motor plate (#3411)
- 2 - Oilite bushings (#3417)
- 2 - Bearing adapters (#3418)
- 4 - 4-40x1/4" allen cap screws (#4145)
- 2 - 4-40x1/2" allen cap screws (#3419)
- 2 - #4 motor mount washers (#3419)
- 6 - 8-32x1/2" f.h. alum. screws (#3324)
- 1 - 3/32" allen wrench (#SP73 or #3616)

Mount the right and left axle brackets onto the chassis using three 8-32 x 1/2" screws for each bracket (see Fig 10). Locate the damper plate (not in a bag) and mount it to the top of the brackets using the four 4-40 x 1/4" allen screws.

If you plan to use ball bearings (#2222 or #897) they should be installed at this point. Otherwise the nylon bearing adapters and oilite bushings should be pressed in place (Fig 11). Run the axle (from the 4/ 7 rear axle bag) through one bushing and up to, but not through, the other bushing. It should

point exactly at the center of the bushing (Fig 12). If it does not, loosen the screws holding the rear bracket containing the axle and swivel the bracket slightly until alignment is achieved. Retighten the screws. Repeat the alignment operation with the other bracket. The axle should now slide freely through both bearings at once.

Save the remaining parts in the rear end bag. They will be used later to mount the motor.

STEERING LINKAGE

Contents of the Linkage bag (#4/ 3)

- 4 - Tie rods (#4125)
- 2 - 1/8" s.s. collars (#4125)
- 2 - 4-40x1/4" set screws (#4125)
- 1 - .050" allen wrench (#4125)
- 1 - Servo saver (#3756/7/8/9)

Locate the four tie rods and trim them as indicated in Fig 13. Locate the servo saver (it may not be in the Linkage bag) and attach one short and one long tie rod to it as shown in Fig 14 (short rod on the right). Attach tie rods to the steering arms (short rod on the right again) and then couple the rods together with collars as shown. Final adjustment of toe-in etc. can be made later. Initially, the linkage should be attached to the longest hole position on the steering arm, and the middle hole position on the servo saver.

BUMPER AND FRONT BODY MOUNTS

Contents of the Body Mount bag (#4/ 5)

- 4 - Body mount posts (#3320)
- 4 - Body mount spacers (#3321)
- 4 - Body clips (#2207)
- 16 - #10 aluminum washers (#3323)
- 2 - 8-32x1/2" f.h. al screws (#3324)
- 2 - 8-32x1-1/4" f.h. al screws (#3325)
- 2 - 8-32x1/2" rnd hd al screws (#4183)

(See Fig 16) The bumper mounts on top of the chassis and is held down by the screws that secure the front body mounts. Use the appropriate screws and spacers for the body you plan to run. In general sports car bodies will require the short screws and one or two washers as spacers. GT bodies will require the

long screws, the tall nylon spacers, and possibly some washers too. Make the final adjustment when you have finished mounting the body.

RADIO TRAY

Contents of the Radio Tray bag (#4/ 6)

2 - 6" Nylon ties	(#3720-6)
6 - 8" Nylon ties	(#3720-8)
2 - 8-32x3/8" rnd hd screws	(#4182)
2 - Fiber washers	(#4146)
1 - 8-32x7/8" flat hd al screw	(#4181)
1 - 8-32 nylon locknut	(#4185)
1 - #8 crescent spring washer	(#4146)
2 - 8-32x1/2" flat hd al screws	(#3324)
2 - Radio tray mounting posts	(#3724)

Refer to Fig 15 and install the radio tray mounting posts onto the chassis the 1/2" flat head screws. The posts should be mounted with the flanges against the chassis. Be sure that the screws start squarely into the mounts. Refer to Fig 17 and install and tighten the 8-32 x 7/8" flat head screw and plain nut to the radio tray as shown.

The remaining body mount posts in bag #4/ 5 attach to the radio tray to support the rear of the body. You have a choice of three holes on each side of the tray on which to place the mounts. Select the pair that best fits the body you plan to run. The middle hole on each side fits most sports car bodies and is usually the best choice. Attach the body posts with the 8-32 x 1/2" round head screws (see Fig 17). Use washers and/or spacers for height adjustment.

The inboard holes are also the holes that mount the radio tray to the chassis. If you wish to use those holes for body posts too, simply replace the 1/2" screws holding the radio tray mounting posts to the chassis with 1 - 1/4" screws. These screws will then stick up through the radio tray and provide "studs" to mount the body posts on.

Installing the radio tray

Temporarily remove the damper plate from the rear end brackets. Refer to Fig 18 and install the radio tray on the mounting posts with 8-32 x 3/8" alum round head screws. Place one fiber washer on the central '9" screw. Replace

the damper plate and attach to the rear brackets. Install a second fiber washer, crescent spring washer, and nylon locknut on the central screw (see Fig 19). Tighten the nut until it contacts the spring washer, and then about 1/2 turn more. This will put a small amount of tension on the fiber washer and cause it to act as a friction-shock absorber. The nut should still be loose enough that you can easily turn the fiber washer with your fingers. The final setting of this adjustment can be made after the car is completed.

REAR AXLE

Differential Assembly

Most 12i kits are equipped with a differential, in which case the kit will contain bag #4/ 7. If your kit box end label is marked "Solid Axle", the kit will contain bag #4/12, and you should skip to the section on solid axle assembly.

Contents of differential bag (#4/ 7)

1 - Diff. axle w/ hub	(#3431)
1 - Ball set (8)	(#3432)
1 - Outer hub	(#3433)
2 - Drive rings	(#3433)
1 - Nylon spur gear	(#3426/7)
1 - Thick thrust bearing washer	(#3434)
1 - Thrust ball bearing	(#3434)
1 - Thin thrust bearing washer	(#3434)
1 - Belleville washer	(#3435)
1 - 10-32 alum. locknut	(#3436)
4 - 1/4" alum. shim washers	(#3435)

Refer to Fig 34. Place the nylon spur gear on a flat surface and snap the 8 steel balls into the square hole of the gear. (Note: Balls can be transferred from one gear to another by laying the gear with the balls on top of the gear without, which is, in turn, laying on a flat surface. Align the square holes of the two gears and use a pointed object like a ball pen or allen wrench to push the balls through to the other gear.)

To insure proper alignment of parts the first assembly of the differential should be done off the car. Temporarily install the set screw wheel hub (included in the wheel parts bag #4/ 4) on the end of the axle that is opposite from the end with the threaded stud. Position set

screw over the flat in the axle and tighten. Install two 5-40 x 3/4" allen screws in a rear wheel. Start the screws into the outside of the wheel (the deep recess is the outside). Run the screws into the wheel until they begin to poke through the backside. Install the wheel on the axle, align the screws over the holes and tighten evenly.

Stand the axle (with wheel installed) on a table with the threaded end up. Test the fit of the spur gear on the axle hub. The gear should fit and turn **very** freely. If it does not the inner hole of the gear should be sanded with emery cloth until a good fit is achieved. This is very important for smooth differential action. Lubricate the inner hole of the gear with a drop of light oil. Oil should also be placed on the surface of the axle between the hub and the threads.

Install one drive ring and gear (with balls) on the axle. Place another rear wheel backside up on the table and install the outer hub and the other drive ring onto that wheel. Grasp the axle with one hand while holding the gear on the hub with the fingers of the same hand, and turn the assembly upside down. Carefully slide the other wheel (with hub and drive ring) onto the axle until the drive ring fully engages the balls in the gear. Re-invert the assembly and stand it on the table. This method of assembly insures that the drive rings and hubs are properly centered.

Drop the thin thrust washer, thrust ball bearing, and then thick thrust washer over the axle protruding through the wheel. The axle should extend into, but not through the last thrust washer. If the axle extends past the washer install thin shim washers between the wheel and first thrust washer to shim the assembly until the axle is flush or slightly inside the last thrust washer.

Install the belleville washer and then carefully tighten the 10-32 locknut, making sure that you don't knock the drive rings and hubs out of alignment. Tighten until the differential feels stiff when turning the wheels in opposite directions. Now, loosen the nut 1/8 turn and while holding the tires use your thumb and attempt to slip the gear by

pushing on it. Repeat this step until you can slip the gear, then tighten the nut 1/8 turn. The differential should work freely now and by holding the gear and rotating one wheel the other wheel will turn freely in the other direction. Remove the wheel opposite the differential by loosening the set screw and sliding the wheel/hub assembly from the axle. Your differential is now set and ready to install in your car.

Under most conditions this setting of the diff will be right. Less differential action can be accomplished by tightening the nut 1/8 turn at a time until you achieve the amount of slip desired.

When changing gears or wheels it is not necessary to remove the differential from the car. Just lay the car on it's side and replace the desired part and readjust per the above instructions.

To make alignment of the outer drive ring easier a drop of super-glue may be placed on the face of the hubs that the drive rings seat on. Hold the ring firmly in place until the glue sets. This will prevent the rings from dislodging during assembly.

Solid Axle Assembly

Contents of the solid axle bag (#4/12)

- | | |
|--------------------------------|-----------|
| 1 - Rear axle | (#3512) |
| 1 - Rear wheel hub | (#3613) |
| 1 - Nylon spur gear | (#3426/7) |
| 1 - 10-32x1/4" set screw | (#3616) |
| 2 - 5-40x3/4" allen cap screws | (#3615) |
| 2 - 5-40x3/16" shoulder screws | (#3421) |

Thread two 5-40 x 3/4" allen cap screws into the mounting holes of each rear wheel. Start the screws into the outside of the wheel (the deep recess is the outside). Run the screws in far enough that they begin to poke through the back side of the wheels.

Mount the nylon gear on one of the aluminum wheel hubs using the special 5-40 flathead shoulder screws supplied. The side of the gear imprinted with "A" and the number of teeth should face **away** from the hub.

Slide the hub onto the axle, gear

side first; follow with a wheel; align the wheel mounting screws with the two holes **not** being used by the gear, and tighten each screw alternately a few turns at a time so that the wheel and hub are drawn together evenly. Position the end of the axle so that it is flush with the outside (recessed) surface of the wheel. Rotate the axle until the flat lines up with the setscrew hole in the aluminum hub. Install and tighten a 10-32 setscrew.

Installing diff or solid axle on car

See Fig 21. Slide the axle through the bearings on the car, gear to the right side; place the other aluminum hub (or wheel and hub if they are already attached together) on the axle, position the setscrew hole over the flat and install the setscrew. Before tightening the screw adjust the hub so that there is a small amount (about 1/64") of end play in the axle. Install the left rear wheel and tighten the mounting screws.

FRONT WHEELS

Contents of the Wheel Parts bag (#4/ 4)

1 - Rear wheel hub	(#3613)
1 - 10-32x1/4" setscrew	(#3616)
2 - Front wheel bushings	(#3653)
2 - 5-40x3/4" allen cap screws	(#3615)
4 - 1/4" alum. shim washers	(#3435)
4 - 1/8" front axle washers	(#4187)

If you plan to use ball bearings (#3655) in your front wheels they can be installed at this time (two per wheel). Otherwise follow the directions in the following paragraph.

Locate the front wheel bushings from the Wheel Parts bag. They should be installed in the side of the wheel with the deep recess. The best way to install the bearings is to slip them over the shaft of a small screwdriver (a phillips screwdriver with a 1/8" shaft and plastic handle is excellent), support the wheel on a block of wood with a hole in it, or you can stack up two rear wheels to use as support for the front wheel while you press the bearing in by pushing down on the handle (Fig 20). Hammering on the bushing can deform the hole causing it to bind on the axle.

Place a 1/8" washer from the Wheel Parts bag on each stub axle (you only need two, the other two are spares). Slide the front wheels in place. Note that the deep recess goes to the inside of the car. Retain each wheel with an "E"-clip.

At this point your car should look like Fig 22.

SECTION 2

FINAL ASSEMBLY

Tools required for final assembly include the following:

- soldering iron (approx. 50 watts)
- 60-40 resin core radio solder
- vinyl electrical tape
- fiber reinforced (strapping) tape

The wire supplied with your kit has a special high temperature insulation, and other types of wire should not be substituted unless rated for 150 deg.C or more. In particular, standard automotive or electrical hookup wire should not be used.

In addition to the parts for the basic kit listed in the first section, the complete kits include additional items arranged in bags numbered as follows:

- #8-6 Charge cord kit
- #4/ 9 Wiring harness and electrical items
- #11 6-cell Ni-Cd pack (4-cell in kit #4013)
- Stock 05 motor

MOTOR INSTALLATION

Press the pinion gear onto the motor shaft until 1/8" of shaft is left showing between the motor and gear. The backside of the shaft **must** be supported while pressing on the gear; otherwise you will push the shaft out of the motor!! The best way to accomplish this is in a small vise with one jaw against the backend of the shaft and the other against the gear. Use a gear puller (#3810) to remove the gear. Attempts to remove the gear by prying between the gear and motor case will only result in pulling the shaft out of the motor.

Temporarily remove the damper plate and radio tray from the car.

Check for and remove any burrs on the metal boss on the motor case behind the gear. See Figs 1 and 4 to identify the camlock adjusting plate (#3411). Slip the adjusting plate over the gear flat-side-first and onto the boss so that it lays flat against the motor cases.

Check to see that it rotates freely on the boss. Position the plate so that the mounting holes in the motor are approximately centered in the slots of the plate. Install the motor and plate assembly into the right-hand rear bracket of the car, with the "cogs" of the adjusting plate pointing up. If the gear mesh is too tight at this point to complete the installation, simply swivel the adjusting plate for a looser mesh by pushing forward on the cogs with your thumb. Rotate the motor slightly until you have the lower mounting hole in the motor aligned with the corresponding hole in the bracket. Install a 4-40 x 1/2" allen cap screw and washer, but do not tighten completely. Install the other 4-40 screw and washer through the slotted opening on the bracket and tighten part way.

Preliminary gear mesh adjustment can be made by rotating the adjusting plate until there is just a small amount of lash in the gears, then lock down the mounting screws. Final adjustment can be made after you have the motor hooked up and running.

WIRING INSTRUCTIONS

BATTERY PACK

With a two inch length of servo tape, tack together the two battery sticks (either 2-cell or 3-cell), such that opposite polarities occur at each end, and the solder tabs point inward (Fig 31). Then wrap each end with strapping tape to pull the sticks tightly together. Overlap the tabs at one end and solder together. Be sure that the tabs are off of the surface of the cells. This care is needed because it is possible to short out a cell if the white insulation is broken through or solder runs under it.

Solder the connector wires on the other end of the pack as shown in Fig 31, with the red lead connected to the positive battery tab. The positive end of the battery can be recognized by the raised center section. Tape the ends of the battery as shown, again using

strapping tape if possible.

RECEIVER POWER CONNECTION

Pin #1 is shorted to pin #2 in the connector of the four cell pack only. This allows the radio to receive the proper voltage with either four cell or six cell battery packs.

RESISTOR AND WIRING HARNESS

Contents of the Electrical bag (#4/ 9)

1 - Throttle resistor	(#3711)
1 - Wiper arm	(#3712)
1 - Resistor mtg bracket	(#3713)
1 - Wiring harness	(#4170)
2 - 2-56x3/8" f.h. screws	(#4180)
2 - 2-56 plain nut	(#4180)
2 - 2-56 nylon locknut	(#4180)
2 - 1/8" washers	(#3216)
2 - #8 washers	(#3323)
2 - #2 self-tap screws	(#3721)

Refer to the Fig 33 pictorial diagram and Figs 23 through 30 for the remainder of the wiring on your car.

Scrape any excess insulation (yellow or orange ceramic coating) from the terminals of the throttle resistor, and bend the terminals up as shown in the inset of Fig 33. Lay the resistor and the wiring harness on a flat surface oriented as follows: resistor flat side up with the terminals toward you; harness three-pin connector on the right, two-pin connector on the left as shown in the drawing.

Tin the stripped portion of the heavy red and black leads. Lay the tinned wires in the V-notch of the resistor terminals, black on the left terminal, red on the right. Solder the wires in place, using a good quality 60-40 resin core radio solder.

The flexible orange lead attached to pin one of the two-pin connector should be stripped, tinned and soldered to the wiper arm. Don't attempt to solder the lead directly over the button; the solder there is a special type. Tape or tie the orange lead to the wiper directly behind the solder joint, using a narrow strip of strapping tape or by wrapping with common string or thread.

Method 1 - The small red and black leads, connected to pins one and three of the three-pin connector, supply power for the radio and take the place of the battery normally used. These leads should be spliced to the leads on the radio's on-off switch. Cut the wires at a point about three inches from the switch. Be sure the wires you cut are the ones that normally plug into the radio battery. Then strip these wires and those on the harness and solder them together, red to red and black to black. Insulate the connection with vinyl tape or shrink tubing. If the wires on your radio are not red and black, then you will need a voltmeter to determine the correct polarity (or consult the radio manufacturer).

This method requires that you find a place to mount the radio switch. If the switch is large you may prefer the alternate method below.

Method 2 - An alternative to soldering the radio switch directly to the harness is to install a plug on the harness wires that mates with the plug on the receiver. You can usually find such a plug on one of the accessory items that comes with your radio. The receiver is turned on and off by making use of the main battery plug or the plug at the receiver.

RADIO TRAY

The steering servo must be reverse rotation. If your transmitter does not have the capability of reversing the servo travel it will be necessary to use a reverse servo.

Refer to Figs 23 and 24 for details on mounting the throttle resistor. The resistor mounting brackets are connected at the center and must be broken apart before use. Note that the brackets are angled slightly in order that the top surface of the resistor ends up level with the tray. You'll have to try both brackets at one end of the resistor to get the correct orientation. The flat head 2-56 screws, used to hold the resistor mounting brackets, fit into counter-sunk holes from under the tray.

Self-tapping screws should not be used because the points stick below the surface of the tray and can short the battery pack. Mount the wired resistor to the 2-56 screws with the nylon nuts.

The throttle servo mounts in the rectangular hole in the radio tray. Small servos (like the S20) will fit the hole as is. Larger servos like the Novak will fit if you break off the tabs in the hole. Two nylon ties work well to hold the servo in place.

Install the battery pack onto the chassis with two strips of servo tape. The pack should be mounted against the radio tray mounting posts with the connector on the right side. Position the pack 1/4" to the left of center to balance the weight of the motor.

Run two strips of servo tape along the length of the battery pack and install the radio tray and damper plate. Tie the battery pack to the radio tray "ears" with nylon ties or strapping tape (preferred).

Mount the receiver directly in front of the throttle servo onto the chassis with strips of servo tape. There should be about 1/8" clearance between the throttle servo and receiver.

Mount the steering servo on the chassis directly in front of the receiver. It may be necessary to cut off the servos mounting ears to clear the suspension arms.

Adjust and bend the linkage wires as necessary to achieve steering action without any binding, and attach the servo saver to the servo.

Push the antenna tube into the hole provided in the radio tray, so that about 3/8" sticks through the under side. Thread a 6-32 nut onto the tube to act as a lock. Run the antenna wire up the tube and knot the wire at the top. Gather the excess wire between the antenna tube and the receiver into a bundle, and tie with a nylon tie. This bundle can later be tied to the radio tray. DO NOT cut off the excess antenna wire, as this will detune your receiver.

Plug the servos and power into the

receiver and tie the excess wire into a bundle under the tray.

The resistor wiper is still hanging loose at this point, and will be mounted after the radio has been tested.

CHARGE CORD

Parts are in the bag marked #8/ 6 or 8/ 4. It will be necessary to solder the alligator clips on the cord before it can be used. Remove the insulation boots from the clips and slide the RED boot onto the SILVER colored wire with the CLEAR insulation. Slide the BLACK boot onto the BLACK wire. Strip the insulation 1/4" back on both wires and solder a clip to each. Slide the boots back on the clips after they have cooled.

The clear-insulated silver wire is a resistance element that controls the charging current. DO NOT shorten the length of this wire.

FINAL ASSEMBLY AND ADJUSTMENT

Refer to page 3 of this manual and follow the FIRST THREE STEPS in order to prepare your car for final assembly. Make sure that the wiper does not make electrical contact with anything after the pack has been charged and plugged into the radio tray connector.

Before proceeding with the following steps make sure the motor connector is unplugged. Install an output disk on the throttle servo. Set the throttle trim on your transmitter in the maximum brake position (the position that rotates the servo clockwise to its maximum). While the servo is in this position mount the wiper to the disk with the wiper contact resting on the brake band of the resistor (the "black wire" end). The wiper should be deflected upward about 1/16" to 1/8" by the resistor to give proper tension to the wiper. Use #2 self-tapping screws and 1/8" washers to secure the wiper. You may have to drill 1/16" holes in the disk if there aren't any in the right position. If one of the wiper mounting holes ends up over the center of the disk, use the disk mounting screw with a 1/8" washer as one mounting point.

Check the swing of the wiper as the servo rotates to make sure it stays in

contact with the flat surface of the resistor over its full length. In particular make sure that the wiper makes good contact with the wide band at the full-throttle end of the resistor. If the servo has too much travel put a stop on the transmitter to limit the travel of the lever. A piece of servo tape can be used for this purpose.

You should by now be able to set the trim so that the wiper comes to rest at any point in the braking portion of the resistor that you wish. This is particularly useful when you are tuning the car to a race track since you can make the adjustment while the car is running.

BODY

Painting clear bodies

Place the body over your car and position it by centering the wheels in the wheel wells. While looking straight down on the body mark the locations of the front and rear body mounts, the wing mounting holes, and the antenna, with a marking pen. These marks will be used to locate mounting holes in the body after painting.

██████ bodies are the strongest, most impact resistant bodies on the market, but the exotic plastic requires special care in painting. Sand the INSIDE of the body with 220 grit sandpaper (except the windshield). Painting should be done on the inside of the body before the body is trimmed. Mask the window areas with masking tape or preferably SCOTCH MAGIC TRANSPARENT TAPE and rub the edge of the tape with your fingernail to make sure it seals so the paint cannot seep under it.

There are few paints that will stick ████████ at all. Enamel and hot fuel proof dope just fall off and very few lacquers will work either. One nationally available spray-can paint that we have found to be foolproof is RUST-OLEUM. RUST-OLEUM sticks very well, does not warp the body in any way, and is fairly fuel-proof. Some care should be taken in its use, however. It is a very "runny" paint and will seep under masking tape if it is not pressed down extremely well. It would probably be a good idea

to use the SCOTCH TRANSPARENT tape instead of masking tape. RUST-OLEUM dries very slowly and should be allowed to dry completely between coats to avoid having different colors run together.

Most vinyl upholstery paints can also be applied directly ████████. They stick well and dry quickly, but since brands vary, they should be tested first.

In order to use other types of paint it is necessary to apply a clear "primer" such as CLEAR No. 2500 "SPEEDY DRY" RUST-OLEUM (not to be confused with regular RUST-OLEUM) or No. 1302 CRYSTAL CLEAR ACRYLIC - KRYLON brand. The 'SPEEDY DRY' sticks the best but it contains a stronger solvent and will etch or distort ████████ if it is applied in too wet a coat. The Krylon can be applied very wet without any body damage. After painting with the clear, let it thoroughly dry, preferably overnight. Then mask it off in whatever pattern or design you choose. You can spray almost any kind of enamel or lacquer over the clear but if you spray enamel - spray all enamel, and if you spray lacquer - spray all lacquer. Do not try to mix lacquer and enamel together. It is always a good idea to practice on a piece of the body you'll be cutting out, such as wheel wells or back paneling, to check paint compatibility. Most automotive touch up paints in spray-cans will work over the clear. If you like candy colors you can use CAL CUSTOM CANDIES, but remember to spray the colors first and gold base last - just the opposite from the instructions on the can. Experiment on a piece of Lexan for the correct candy coloring.

Trimming

Using a very sharp knife or scissors, or a small tipped soldering iron, follow the trim lines around the sides and cockpit area and clean up with a sanding block, course file, or a burr on a hand grinder. Note that some of the older style bodies have a spoiler outlined on a portion of the rear plastic that is normally cut away. Take care not to damage this while trimming. The spoiler can be mounted to the body with contact cement or the appropriate plastic glue.

Locate the marks you made before painting and drill 3/16" holes at each point. Enlarge the antenna hole to 3/8" approximately, and then place the body on the car. Check the position and fit of the holes to the mounting posts and wing tubes, and enlarge or elongate the holes as necessary to allow the body to drop freely onto the mounts. The rear mounting holes should be elongated slightly lengthwise so that the body does not restrict the up-and-down flex of the chassis. The body is held in place by body clips (#2207 or 2208) in both the front and the rear mounting posts.

If you plan to use a wing on your car you should cut clearance holes in the body directly over the wing mounting holes in the rear brackets. The holes should be elongated slightly to allow for the suspension motion of the rear end - the wing wire should not touch the body when you flex and twist the rear end with respect to the midsection of the car.

Peel and stick sponsor decals (No. 3820), vinyl racing numbers (No. 3821), or other types of decorations such as MONOCOTE stripes can be applied to the outside of the body to give a realistic appearance.

[This sectional divider page was left blank in original manual]

SECTION 3

OPERATION

The instructions on page 3 of this manual will get you started running. However, before too long you should read this section. The information here will help you maximize the performance of your car, and will introduce you to the exciting sport of organized R/C racing.

CHARACTERISTICS OF Ni-Cd BATTERIES

It is important to understand the characteristics of the battery pack in your car because how you use it will greatly affect both its performance and life. With proper care your pack will give you top performance for many hundreds of cycles.

The R.O.A.R. legal battery supplied with your car is composed of either four or six "sub-C" size cells with a maximum rated capacity of 1.2 amp-hrs. This means that the cells will supply 12 amperes for one hour, or 0.6 amperes for two hours, etc. This capacity rating drops to about 1.0 amp-hrs. at high drain rates. For instance at six amperes (a typical average current drain for an electric car) the cells would discharge in 1/6 of an hour or ten minutes. This charge capacity is the same regardless of the number of cells in the pack because the cells are connected in series and the same current passes through each one. In other words, the charge capacity of a four pack is the same as a six pack. The total energy storage of a six cell pack is higher, of course, because the voltage is higher.

Ni-Cds are very efficient and they give back almost as much charge as you put in, as long as you don't try to put more charge in than they will hold. If you start with a completely dead pack and charge at four amperes for 1/4 hour, you will have put a total of one amp-hr (4 x 1/4) into the cells. More than 95% of the charge would be recovered if the pack were then discharged at the one hour rate.

Overcharge

There is no way to make a Ni-Cd cell accept more charge than it is designed to hold. This means that the charging efficiency begins to drop off as the cell

approaches a fully charged condition; and the portion of charging current not being stored becomes heat and pressure. If charging continues after the cell is fully charged, all of the current is converted to heat and pressure - about 40 watts worth - or the equivalent of the heat produced by a medium sized soldering iron.

Heat and pressure

Either excessive heat or excessive pressure is harmful to the cells; and getting rid of one doesn't help the other. For example, cooling the battery with a fan while it's being overcharged will do nothing to stop the pressure build-up.

Excessive pressure momentarily opens a safety vent in the cell and a small amount of electrolyte is lost in the process. One such occurrence is not harmful, but frequent venting will permanently reduce the performance of the cell. Excessively high temperature can permanently damage the separators. However, high temperature also has temporary (and bad) effects that will be explained later.

Ni-Cd cells have a built-in process for recombining the accumulated gas (actually oxygen) produced by overcharge, but the process produces heat and takes a lot of time. If you overcharge your battery and it seems to take a long time to cool down, it's because this pressure reducing reaction is taking place. Once the gas is recombined the temperature drops.

A hot Ni-Cd pack cannot be fully charged. At 130 deg. F (a temperature uncomfortable to touch for more than a few seconds) the cells will only accept about 50% of a full charge. This doesn't mean that a fully charged battery will lose charge if it's heated; it just won't

accept a new charge efficiently. For this reason it is always better to allow the battery to cool before charging. A fan is helpful to speed the cooling process.

Excessive discharge

When a Ni-Cd pack is deeply discharged it is inevitable that one cell will run out of charge before the rest. When this happens the remaining cells continue to supply current to the motor but this current passes through the dead cell and "over-discharge" it, or actually tries to charge it in the reverse direction. The cell won't accept a reverse charge and begins to evolve a gas (this time it's hydrogen). There is no chemical reaction to get rid of the hydrogen, so once it is formed it stays until the cell vents. Usually the same cell is reversed whenever the pack is over-discharged, and hydrogen pressure builds each time until the cell vents. Repeated venting will eventually dissipate the cell's electrolyte.

Chargers

All fast-chargers and fast-charge cords do basically the same thing: supply a charging current of about 3 to 5 amperes. Where they differ is in the power source they use (either 12 volts d.c. or 115 volts a.c.), and in frills and accessories. Some chargers have timers that offer a certain amount of protection against accidental overcharge. Some have ammeters and discharge circuits. Others are capable of charging either four or six cell packs. Features like fault detection, slow-charge, voltmeters, and constant-current are all convenient, but naturally the more features a charger has the more expensive it becomes. There are no chargers on the market right now that have all of these features; and above all, there is no charger that "knows" when to stop charging. The operator has to know that.

HOW TO TELL WHEN YOU'RE CHARGED

One of the problems with Ni-Cds is their inherent voltage stability; the voltage of a fully charged cell is not much different from one that's about dead. For that reason several

indicators, along with some common sense, are needed in order to get the most out of your battery. The following is a list of indications you should use to detect full charge.

Temperature Method

This only works if you start with a cool battery pack. As the pack charges, frequently check its temperature by feeling the cells directly (you'll need a hole in the battery cup). As soon as you notice an increase in temperature stop charging. If the cells become too hot to hold on to, you are way overcharged. Let them cool.

Timed Charged Method

This only works if you have confidence in the timing accuracy of your charger. Many chargers on the market only approximate a constant charging current; they may vary from six amps when you first start charging all the way down to two amps if the Ni-Cd pack is nearly charged and the voltage of the charging source (automobile battery) is low. If the charging current varies, it becomes difficult to estimate the average current. However, if your charger is reasonably dependable you can use the following method.

Cycle your pack several times using the "temperature method" above. After you run the car the last time let the pack cool. Charge again using the temperature method but this time keep track of the time required to reach full charge. Once you have established the time you can use it as a setting for the timer on your charger. To be safe use a setting about a minute less than what you established. This method allows you to charge without constantly monitoring the battery temperature.

If you charge a battery that is still hot from running, reduce the time about 20%. Then, after the pack has cooled, finish charging with the temperature method. The reason for this will be explained later.

Voltage Method

As mentioned earlier, voltage is a poor indication of a cell's state of

charge. The change in voltage from 10% charged to 100% charged is usually less than 0.1 volts per cell. In fact other things like temperature, current drain, and "cell memory" have a greater effect on voltage than the state of charge does. However, if current flow and temperature are held constant, it is possible to see the cell voltage gradually climb during the charging process. The absolute value of this voltage isn't much use, but how the voltage changes is an excellent indication. To use this method you will need a digital voltmeter or an expanded-scale voltmeter capable of resolving 0.01 volts on the 10 volt range.

Connect the voltmeter across the Ni-Cd pack, preferably right at the cell terminals, or if that's not possible, across the terminals of the throttle control resistor. Don't try to read the voltage at the output of the charger because you'll end up reading the voltage drop through all the connectors and cables between the charger and the Ni-Cd pack; and that can sometimes mask the effect you're looking for. You should start with a Ni-Cd pack that is less than 1/2 charged. Connect your charger and begin charging at four amps. If your charger is adjustable set the current now, but don't try to change it later. A constant current charger is preferable here, but if yours gradually drops off during charge, that's okay; as long as it doesn't drop below three amps.

Watch the voltage as the pack charges. Notice that the voltage climbs rapidly at first, and then very slowly in the middle of the charging cycle. This voltage will most likely be in the range of 8 1/2 to 9 volts for a six cell pack and 5 1/2 to 6 volts for a four cell pack. As the pack approaches full charge, the voltage will begin to climb more rapidly; and as it goes into overcharge the climb will slow down and stop. This is where you stop charging: at the point where the voltage stops climbing. If you left the charger on, the voltage would begin to fall as the pack went deeply into overcharge and started to heat up. The maximum voltage reached will probably be in the nine to ten volt region; the actual value is unimportant. Do not try to use a conventional voltmeter. Even a good

qualify VOM with a large, taunt-band, mirrored-scale meter movement is not adequate; by the time you could see that the voltage had stopped rising, it would be too late.

Slow Charge Method

Slow or "over-night" charging is a method you are not likely to use often. However, it is a good way to bring the pack to absolutely full charge.

The charging current must be between 0.05 and 0.12 amperes. Any less and the pack will never reach full charge; any more and the pack will overheat. The time required to reach full charge ranges from 15 to 40 hours depending on the current used. The charger can be left on for a much longer time without harming the cells, but the output voltage of the pack will be temporarily lowered by an extremely long overcharge. The voltage returns to normal after a discharge-charge cycle.

Last Word on Charging

Quite a few charging methods have been presented here in an attempt to satisfy the needs of everyone from the weekend hobbyist to the serious racer. Getting that last 5% of charge is the hard part, and obviously if you're just out driving for fun it isn't necessary to try for that last little bit all the time. Properly cared for, your packs will last many hundreds - even thousands - of cycles. Pushing them into overcharge constantly will definitely reduce their life.

GETTING MAXIMUM VOLTAGE TO THE MOTOR

The paragraphs that follow are really for the benefit of serious racers only, since they deal with factors that influence the voltage and available power of a Ni-Cd pack. We're talking about a difference of maybe 15% at the most, so if you're just out having fun, don't worry about it.

The output voltage of a fully charged pack can vary considerably depending on the temperature and recent activity of the pack. These effects are listed below.

Hot Means Slow

Again high temperature has its bad effects, this time by lowering the output voltage under load. Less voltage means less speed. At normal 130 deg. F the voltage of a six cell pack can be almost a volt less than normal.

Memory

There are three "memory" effects that can affect the output voltage. One is caused by overcharge. The cells "remember" that they were overcharged and put out less voltage near the end of the discharge cycle. This is particularly noticeable if the pack is slow-charged for too long a time.

The second memory effect is caused by repeatedly not using up all of the battery's stored charge before recharging. The cells "remember" that they aren't fully used and let the voltage drop off to about one volt at the point where discharge usually stops. An example would be where you run a series of five minute heats, recharging between each heat, and then try to run an eight minute heat. The battery voltage will be low for the last three minutes of the race. The cure is to fully discharge the pack before recharging. "Full discharge" means the point where the first cell goes dead. Never discharge beyond that point.

The third memory effect is the "topping-up" effect of recent charging. The cells remember that they were recently charged and will produce a little more voltage early in the discharge cycle. Racers take advantage of this by putting the last minute or two of charge into their pack just before the race starts.

Summary

- Don't overcharge - use the "voltage method" of charging, if possible.
- Don't over-discharge.
- Keep your battery as close to room temperature as possible.
- Fully cycle your battery before a long race.
- "Top-up" just before the start of a race.

TUNING THE RC12i

As you begin to run your car in competition you will want to take advantage of some of the design features and accessories that can make your car the fastest on the track.

The 12i is a state-of-the-art design involving several new concepts. Tuning and adjustment of the car is NOT the same as other R/C cars. Please give careful attention to the following points.

Rear End Adjustments

The rear axle and bearing blocks are suspended from the rest of the car by two fiberglass "flexures" running on either side of the motor and beneath the bearing blocks. These flexures must be free to move and should not rub against the motor or motor adjusting cam. A large washer on the lower motor mounting screw can interfere with the flexure on that side. Over tightening the lower motor screw can expand the plastic around the screw head causing interference. The freedom of this suspension action should be periodically checked.

The RC12E motor adjustment cam had large external "teeth" that can interfere with rear suspension action if the motor is pivoted far forward for a large pinion gear (the cam "teeth" bump into the battery). The new cams have much shorter teeth so there is no problem. If you need to use an old cam on the 12i, simply shorten the teeth with an Xacto knife.

Damper Plate Adjustment

The damper plate is essential to the operation of the 12i. It functions as a shock absorber, a suspension travel stop, and a box section brace for the rear end. When the damping washers are adjusted properly they provide a smooth even drag as the rear end is moved about. If there is any roughness you should examine the washers and damper plate for dirt or damage.

Always use the proper spring washer between the nut and the top washer. The nut should be adjusted to that the spring washer is only partially collapsed. The

setting can be tested by lifting the back end of the car about 2 inches and letting it drop on the ground. If the damper is set right the car will hit the ground with a dull "plop". If the setting is wrong you will see or hear the rear tires bounce several times.

Wing Mounting

A hole is provide in the top of the rear bracket and damper plate for 1/16" piano wire wing supports. Kink the wire slightly and it will snap into the brackets firmly. The clearance holes in the body **must** be large enough to allow free movement of the rear end when the wing is in place.

Steering Linkage

The 12i is designed to have a lot of turning ability. This means that it doesn't take much steering "lock" to make the car turn. In general you should use much less lock than you are used to using. If your transmitter has a rate trim, set it to minimum to start with. Otherwise you should adjust the linkage to give less that half lock.

Never run the lock up to the point where the steering arms hit their stops. The cars handling gets VERY bad at that point!

Steering Blocks

The 12i steering blocks have very close to zero caster offset (it's 0.05"), which means they are best on fast, high-bite surfaces. If you run on a slippery surface you may want to purchase blocks with more offset. Check the 12i catalog for the release of these optional blocks.

Tweak

If your car seems to turn better in one direction than the other, or if it tends to pull to one side under acceleration, you should check the "tweak" of the chassis. Neutral tweak is when all four wheels sit on the ground with equal force. When one front wheel presses down harder than the other, the car will tend to veer in the direction of the "heavy" wheel. The condition can be caused by unequal tire sizes, a slightly

twisted chassis plate, or by unequal heights of the front suspension arms.

Tweak can be corrected by replacing the tires if that is the cause, or by equalizing the height of the suspension arms by shimming or by lightly sanding the underside of the appropriate arm.

You can check for tweak by placing your car on an absolutely flat surface and then lifting each front wheel separately. Each wheel should come up the same distance before the other wheel lifts. You'll be able to detect large tweaks this way, but small ones may be noticeable on the race track. Some racers purposely tweak their car one way or the other to suit a particular track.

Gear Ratios

A total of three axle (nylon) gears and three motor gears are available. These can be used in the following combinations to give the ratios indicated.

PINION	AXLE	RATIO
12	48	4.00
12	46	3.83
13	48	3.69
13	46	3.54
14	48	3.43
14	46	3.28
14	44	3.14

The "lower" gear ratios (4.00 etc.) will give a lower top speed and a longer run time per charge. High gear ratios (near 3.14) will give the highest top speed at the expense of run time. The choice of ratio depends on the track you run on. Usually a track with a long straight and high speed turns will require the higher ratios.

Body and Wing

Believe it or not, the aerodynamic effects of the body and wing are more important than you could possibly imagine. It works the same way on model cars as it does on full sized cars: Formula bodies have less drag and can achieve higher speeds with less horsepower; blunt, scoop-nosed, Can Am sports car bodies like the Porsche 917-30KL have more steering than

round-nosed bodies like the Ferrari 312PB; all Can Am bodies are more stable and generally faster than all coupe and GT bodies; etc., etc. The better a driver you become, the more you will notice, and be able to use, these effects.

Even a beginning driver can notice the effect of a wing. Wings aren't used on 1/12 scale cars as often as they are on 1/8 cars because the additional drag is more noticeable on the smaller cars; but on a slippery surface there are times when a wing is indispensable for good handling. A high, steeply angled wing gives great stability, at the expense of top speed and steering.

Tires

The handling of the car can also be affected by changing to a different front tire rubber. Kit cars come with #3664 medium traction front tires which are good for most track conditions. However, on some commercial tracks where the bite is very high, you can use the additional steering provided by #3656 (S-K) or #3657 (Soft) tires. You can even get "in-between" steering by putting a #3664 on one side and a #3656 on the other. Generally it is best to put the soft tire on the inside of the high speed turns.

Working on Details

Like any competitive sport, the more time you spend on details the better will be your chances of winning. Anything that reduces the rolling friction, air drag, or weight; anything that increases the power to the motor; or improves the handling in the turns, will give you a competitive edge. Here are a few examples.

Reduce bearing friction as much as possible. You can do this by making sure the rear brackets are perfectly aligned. Polish the front and rear axles with crocus cloth. Use a good quality, extremely light, moly and graphite oil for the bushings and motor. Polish the sides and reduce the O.D. of the thrust washer on the front and rear axles.

Work for the best possible gear mesh. Make sure that the gear fits

properly on the gear hub: without the two gear mounting screws in place, the gear should turn easily on the hub. Sand the hole if the fit is too tight. At the same time make sure there are no burrs or bumps on the side of the gear that goes against the hub. After two mounting screws are installed and tightened, the gear should be able to rotate slightly on the hub. Doing this will insure an absolutely quiet and friction-free gear mesh. Set the mesh carefully, listening to the sound and checking the lash. The final setting should have very little lash and yet be very quiet. On the track other noises such as the sound of the tires scrubbing on the ground, or the body rattling on the mounts should be louder than the gears.

RACING ACCESSORIES

The TUBULAR STEEL AXLE (No. 3450) is less than half the weight of the stock axle, and is legal for all classes of racing including stock.

A WING (No. 3182) can be very useful on slippery tracks and is legal in all racing classes.

BALL BEARINGS are available (No. 3655,2222) for the front and rear wheels, and can be fitted to the car in a few minutes. Ball bearings have less friction than bushings and increase the speed of the car considerably. A lighter bearing (No. 897) can also be used in the rear (with adapter No. 3418). Ball bearings are not legal to use in stock class racing.

PRECAUTIONS

Do not stall the motor under power. If the car stops suddenly on the track, or fails to move forward when you attempt to accelerate, push the throttle control on your transmitter to the brake position immediately and attend to the car. A small rock can stall the gears, and if the throttle is left in the on position the result can be a burned out motor or resistor (or electronic speed control unit).

If you run your car to the point where more than one cell in the pack is completely discharged, it is possible to lose radio control of the car before the

drive motor stops completely. For this reason you should not operate your car in an area where it could be harmed, such as near a busy roadway or a pool of water. Usually radio control will be regained as soon as you pick up the car and the motor is allowed to free-run. If you still don't have control, then you should unplug the motor.

Don't operate your car on thick pile or shag carpets. Long fibers from the carpet can wrap around the axle and motor shaft causing them to bind.

When you stop running your car, turn off the radio at the car first (with the resistor in the off position) before turning off the transmitter.

Be sure that the resistor is in the off position while you are charging the battery.

A partially burned-out or shorted motor can make the car appear to have radio problems. If the car slows down suddenly and the radio acts erratically even with a full battery charge, then the cause is probably the motor. Check the range of the radio with the motor unplugged. A shorted motor will draw extremely high current even under no-load conditions.

HOW TO START RACING

Although R/C car racing is growing very fast, there are still many areas that are not organized yet, to the point of having clubs and regularly scheduled events. Even in areas where there is strong club activity, it's hard for the beginner to find clubs and racing events.

You can write to R.O.A.R., 12008 Welland, Cumberland, IN 46229 and ask them for the name and address of the club nearest you. R.O.A.R. (Radio Operated Auto Racing), the National Organization, keeps a record of clubs in the USA. New clubs can also send in their name and address to R.O.A.R. to add to this list so that new racers in their areas know where to contact them. Also, you can join R.O.A.R. and receive a copy of Revup every other month. Revup is a R.O.A.R. publication that keeps the members informed of what's happening around the country.

If there is no organized activity in your area yet, it would be very easy for you to start it up. Ask your local hobby dealer if it would be all right for you to post a small 8" x 11" notice in his shop about R/C cars. On the notice, you could have a photo of an R/C car. You could also state something to the effect that "Every Sunday afternoon, at 1 pm, there will be a demonstration of R/C cars in the parking lot at Main St. Shopping Center, at Main and Broadway Streets. For further information call Joe Racer at 637-7654". Change the wording around to suit yourself. The important thing is to take the first step and get the notice posted in the hobby shop. Pick a location to run on that has a lot of exposure to people walking by. There are an awful lot of would-be car racers that would like to race, if they only knew that there was such a thing as an R/C car. If you run on a parking lot where no one can see you, then there will be no new people to join your fun.

Wherever you run, try to keep some kind of safe crowd control. Don't let the people get too close to where you're actually driving. And it's not necessary to show the crowd how fast you can go. It's much better to set up a simple course and just drive around on it. When you stop running, be prepared to answer a million questions. This is a VERY IMPORTANT step. The interested spectator is what it takes to become a future R/C car racer. You'll be answering the same questions a hundred times, but if you can get 4 or 5 guys really interested, you've got your club started.

Once you get 2, 3, 4 or 5 guys running at the same time, then it's a lot easier to get more new people interested. It's fun running by yourself, but it's a whole lot more fun running with other racers.

Most hobby shops would be glad to let you post notices of your R/C car activities. It wouldn't cost them anything to do so, and they know that you would be helping them by bringing in new customers for them.

Some hobby shop owners are a little apprehensive about R/C cars, mainly because they're quite familiar with airplanes, but they don't know anything

about the cars. Clean up your car and show it to the hobby shop owner. He would be glad to take the time to look over your car while you explain the different parts to him. As soon as he finds out the cars are a lot easier to understand than he might have thought, he'll be much easier to work with.

Don't expect him to rush right out and put in a huge stock of R/C cars. It doesn't work quite that way. In the beginning he'll be glad to order whatever parts you need, as well as a complete car for a new customer. When there are 4 or 5 racers in his area, he'll probably start to stock a few parts for them. As the number of racers grow in an area, you'll also start to see the stock of R/C car parts growing in the hobby shop.

When you get up to 5 or more racers, it's time to form a club. With your club formed it's then time to have regularly scheduled events. Normally a two week spread between races is good but you can vary this to suit your club. In So. Calif. between the 1/8 and 1/12 scale clubs, there are from 1 to 4 races every weekend, year round, between nine clubs. And it's still growing.

With your club formed, you should start to collect dues. Don't make it too much to begin with, you don't want to scare anyone off. You'll need some money to make boards to surround the track, to protect the spectators from your overly enthusiastic driving lines. As your club gets larger you'll want to buy clocks and a P.A. (public address-loudspeakers) system.

For your first races you should also present trophies. About one trophy for every 4 or 5 competitors is enough. Trophies are very important because there's nothing else in the world like winning your first trophy. The trophies are paid for by the race entry fees, the amount of which is determined by your club members, \$2, \$3, \$4 or whatever you decide on. Trophies should be awarded at the conclusion of the day's events.

Some of the largest, fastest growing clubs hold their races in parking lots located at large shopping malls. Some of these malls have advertising funds that they use to pay the clubs \$50 to \$150 a

race. This money is then used to buy the race trophies. The club is then free to use the entry fees to buy a trailer to haul the boards or for whatever purpose they need. The shopping mall manager should be approached by someone in your club who can give the appearance of being a responsible person. Your club representative can bring along a nice clean car and maybe some photos of races, so the mall manager knows what you're talking about. In the beginning, it's best to just ask for permission to use part of the parking lot which is least used. They'll not be in a hurry to give you a parking lot that is used regularly. Don't ask for money right away. Run a few races first to see if you attract an audience. Then you can ask the mall manager if they would like to contribute to the trophy fund. Also, at your initial presentation to the mall manager, you can tell them that you will be getting site insurance for yourself, your club and site insurance from R.O.A.R., Inc. Write to them for details. Naturally, you'll want to clean up the area after the day's racing, because this is also very important to the mall manager.

You will also need insurance if you plan to compete in a R.O.A.R. sanctioned race such as the Nationals. The insurance is not expensive and can be handled in conjunction with your membership in R.O.A.R.

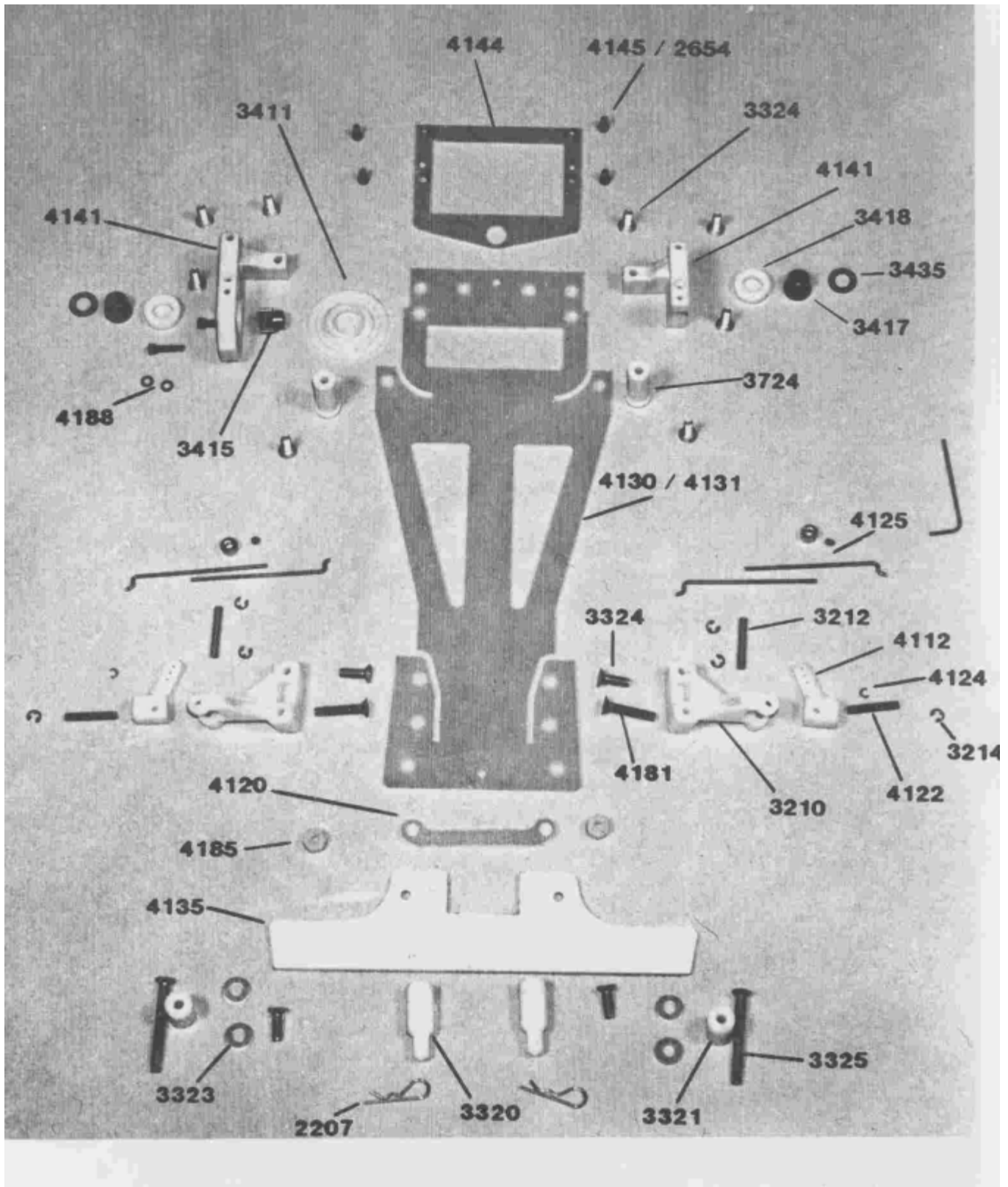

Fig. 1

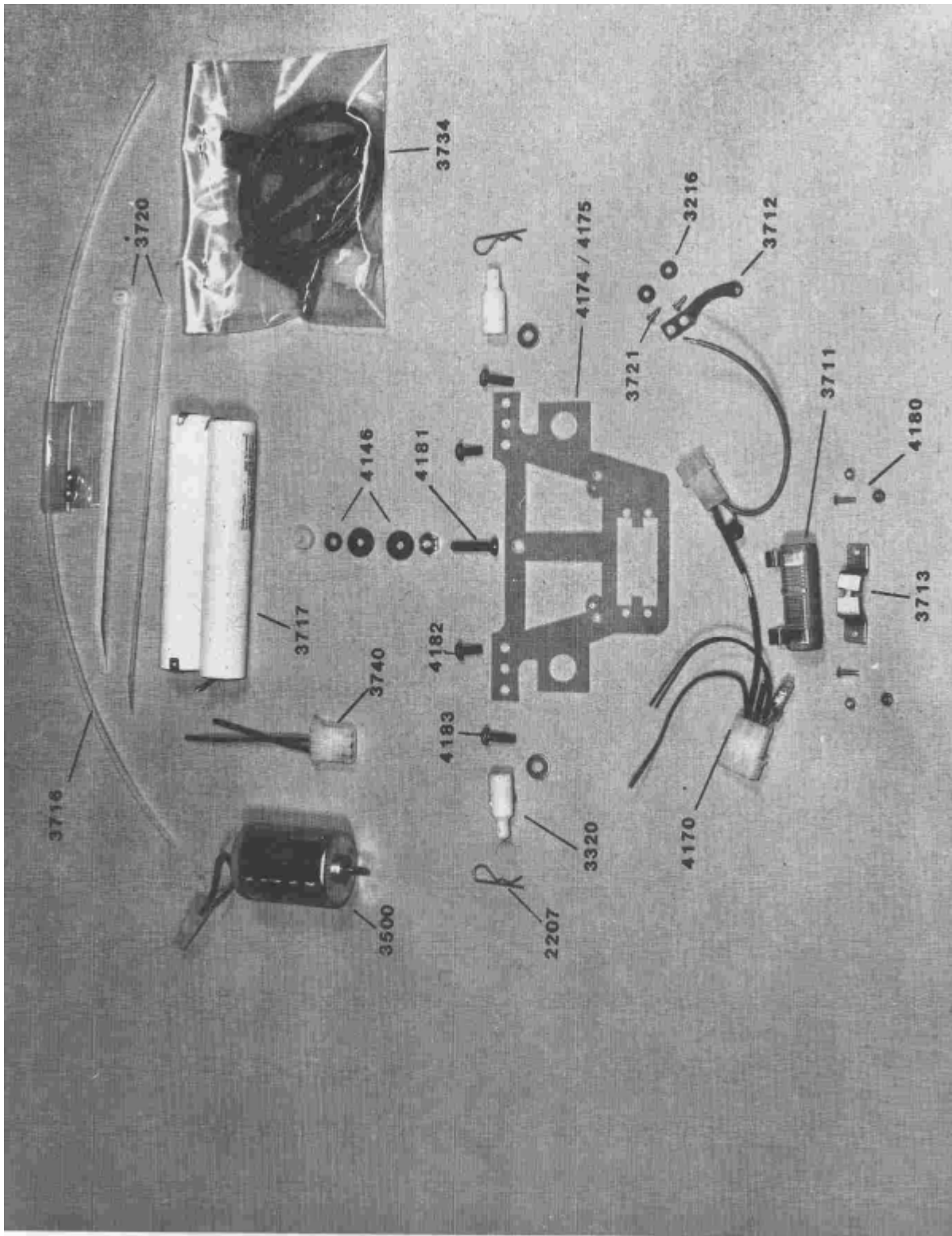

Fig. 2

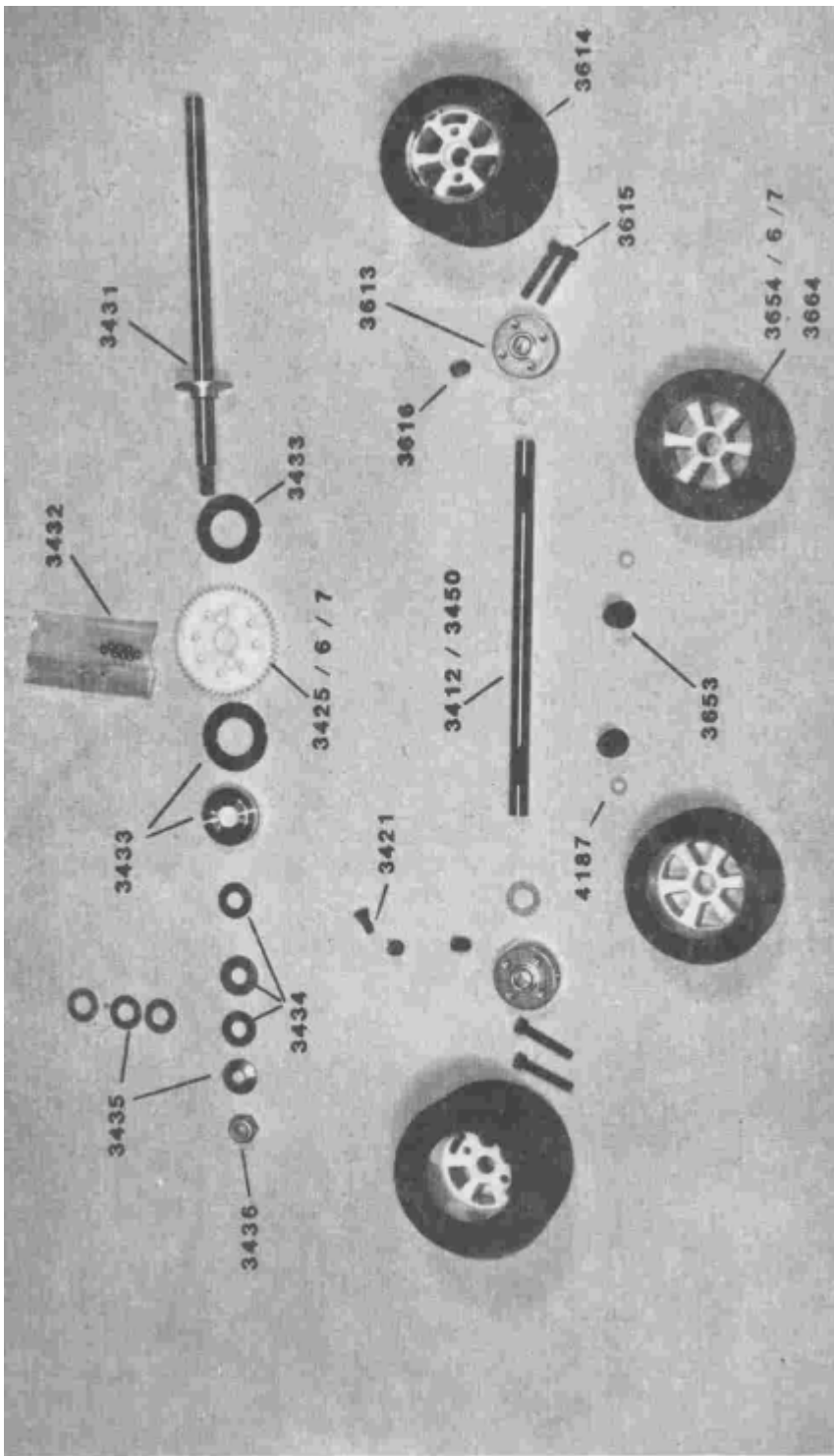
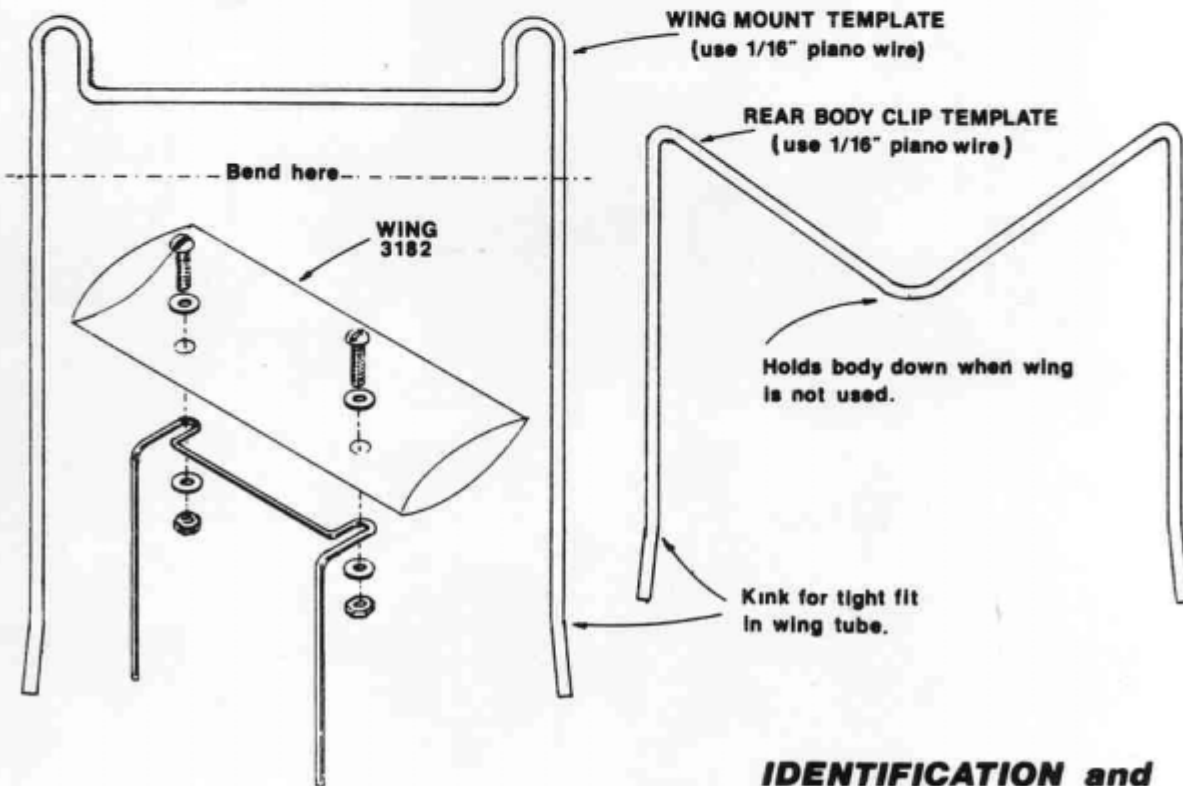
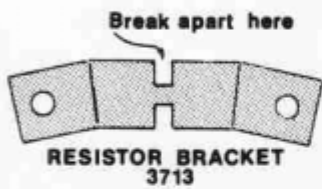
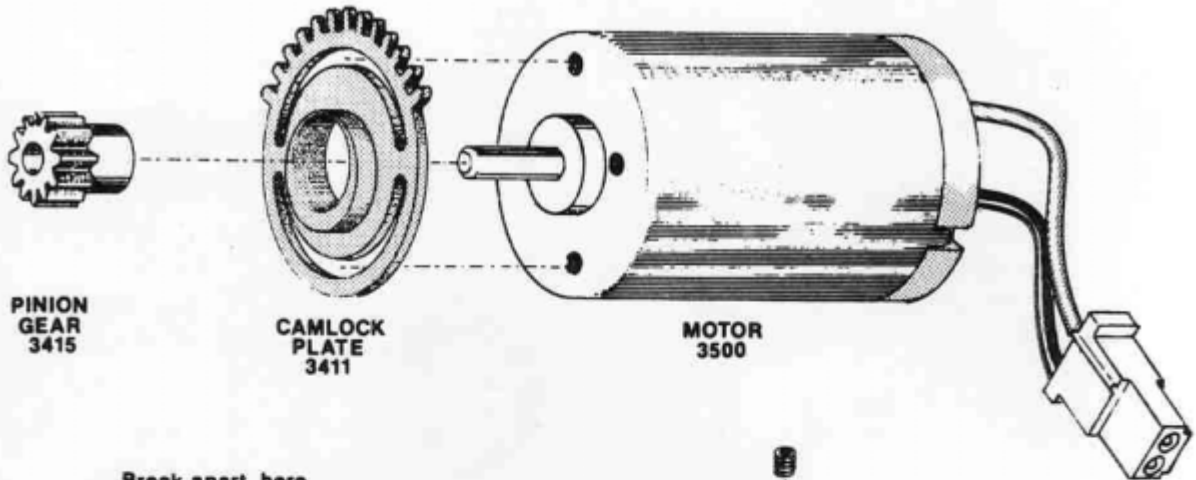

Fig. 3



IDENTIFICATION and TEMPLATE CHART

Fig. 4

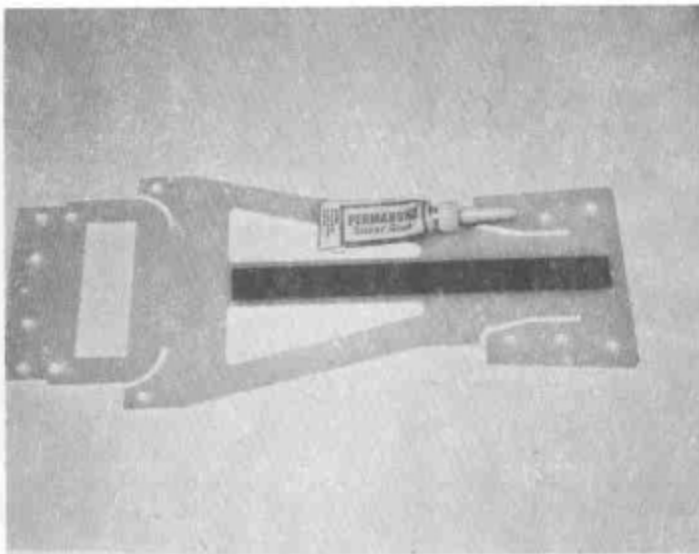

Fig. 5

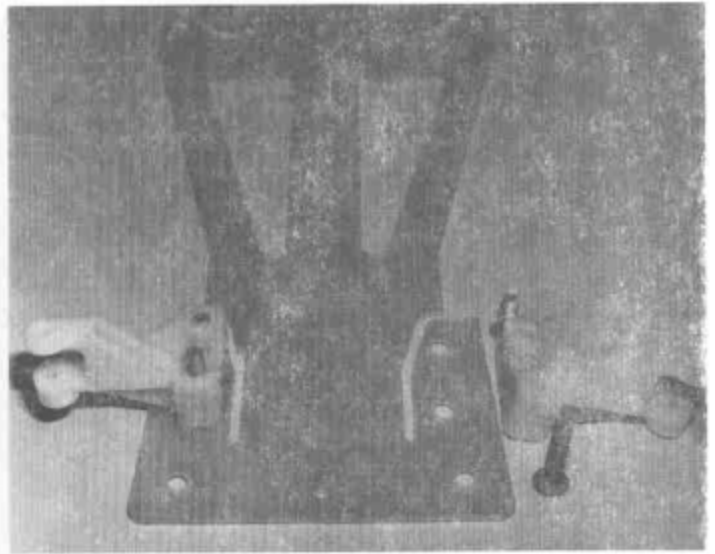

Fig. 6

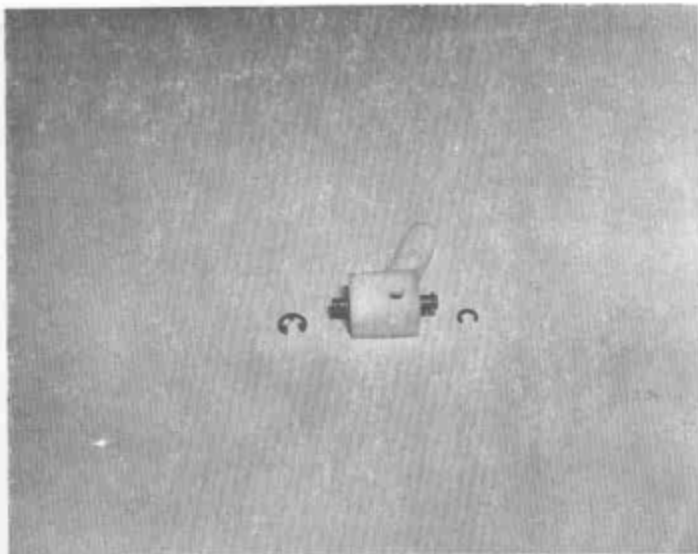

Fig. 7

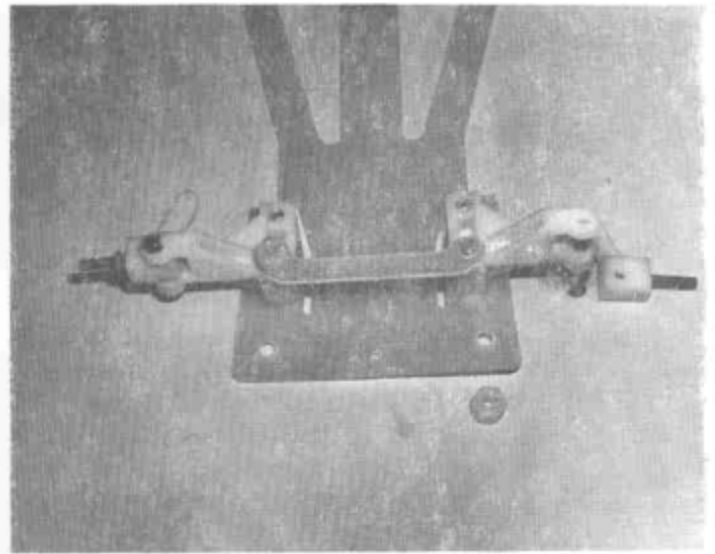

Fig. 8

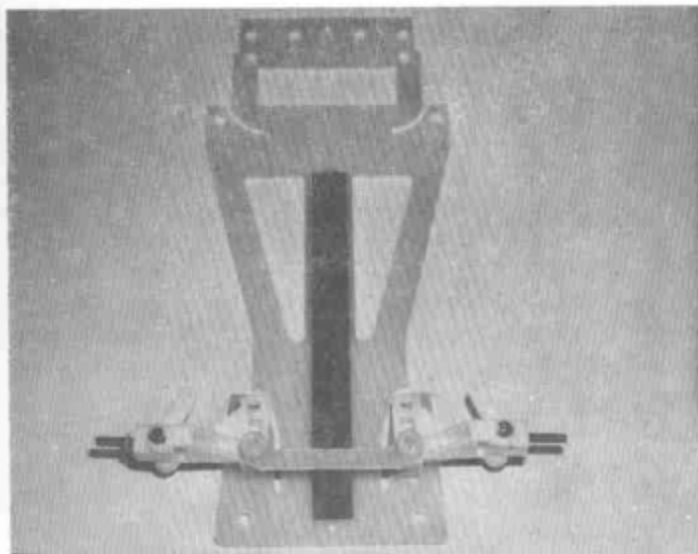

Fig. 9

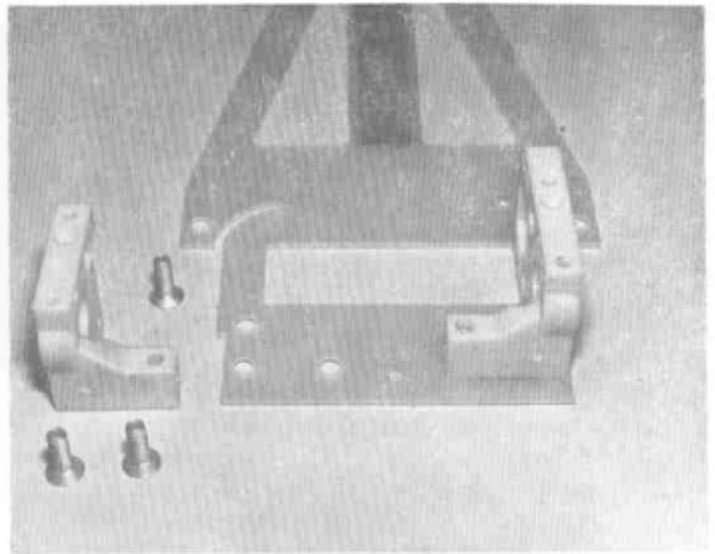

Fig. 10

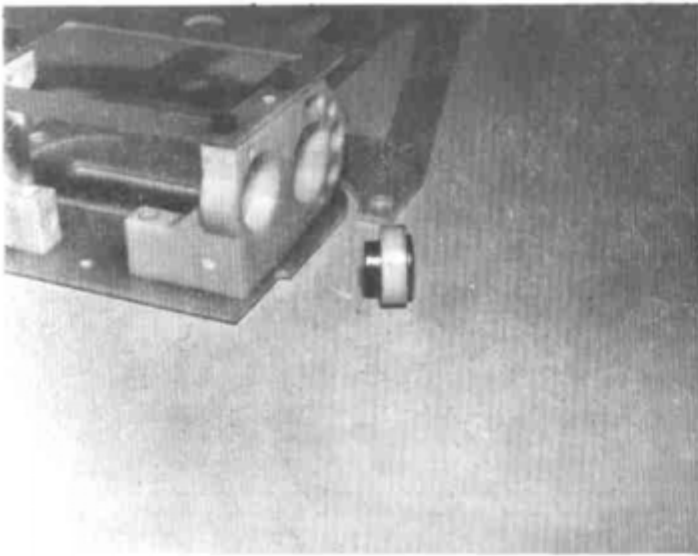

Fig. 11

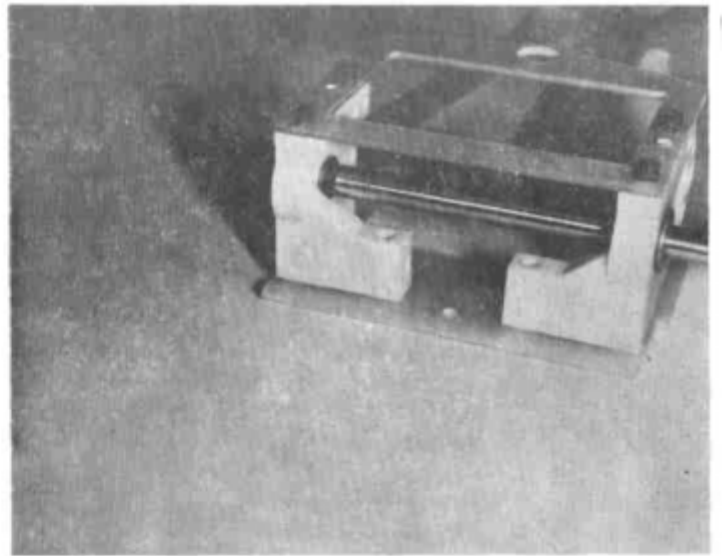

Fig. 12

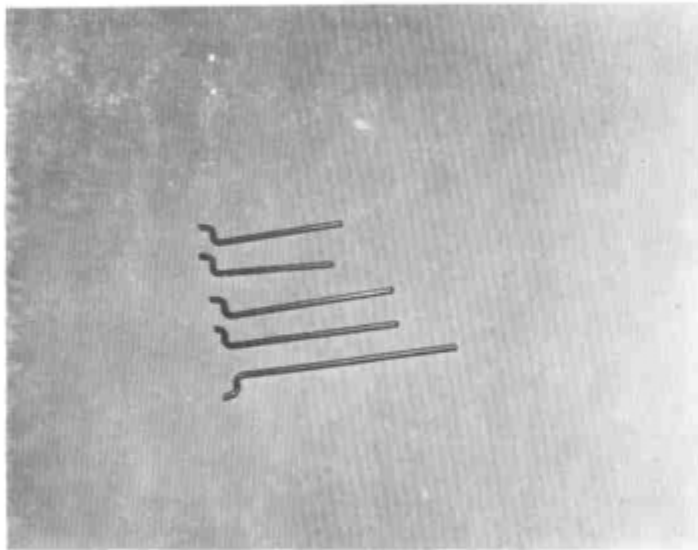

Fig. 13

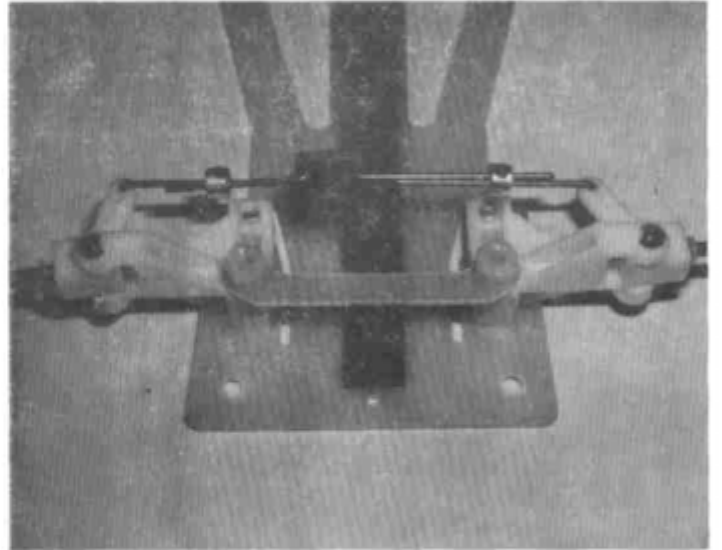

Fig. 14

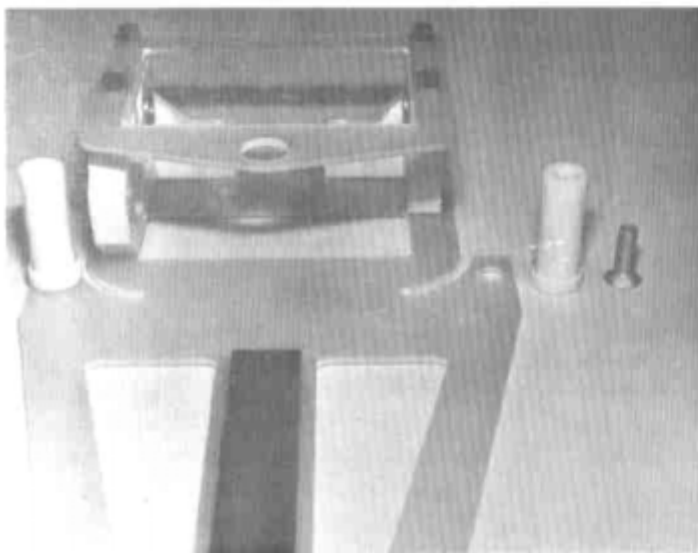

Fig. 15

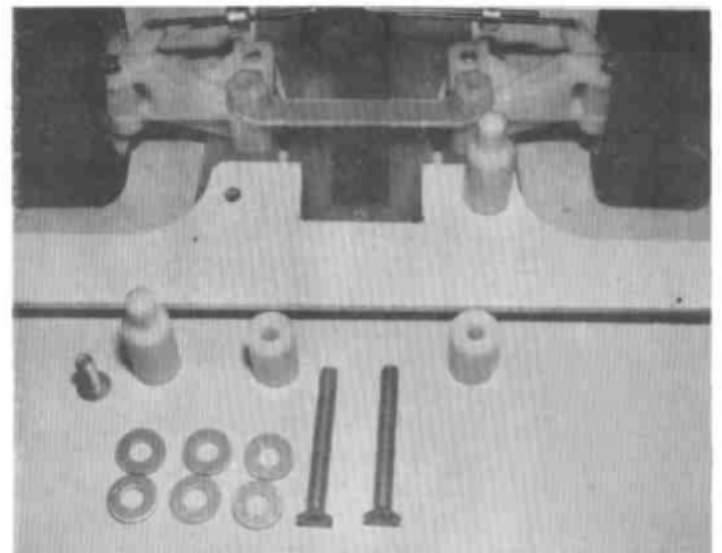

Fig. 16

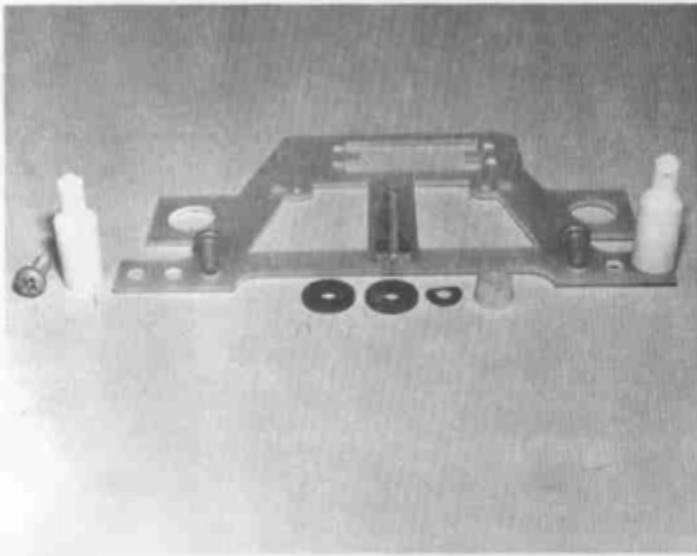

Fig. 17

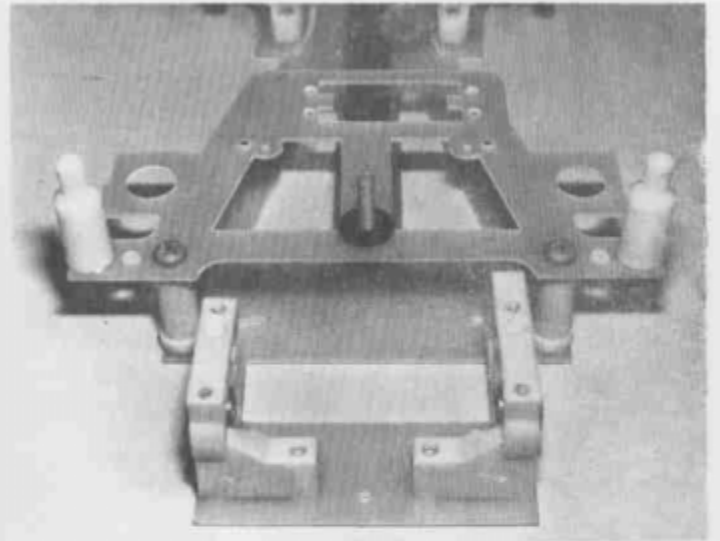

Fig. 18

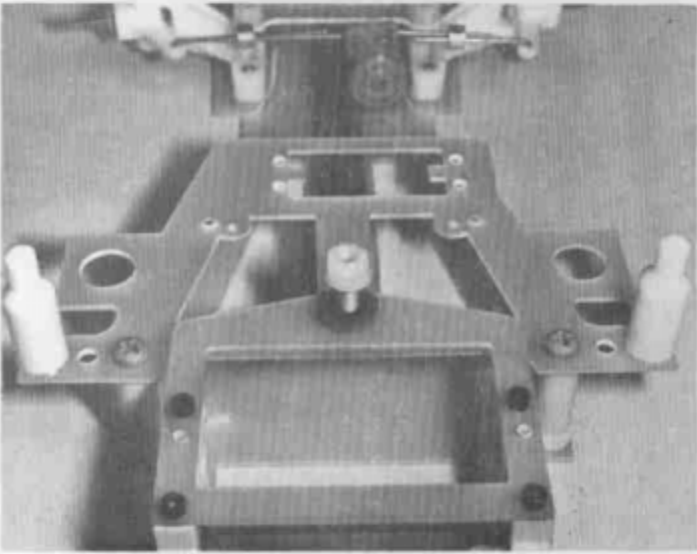

Fig. 19

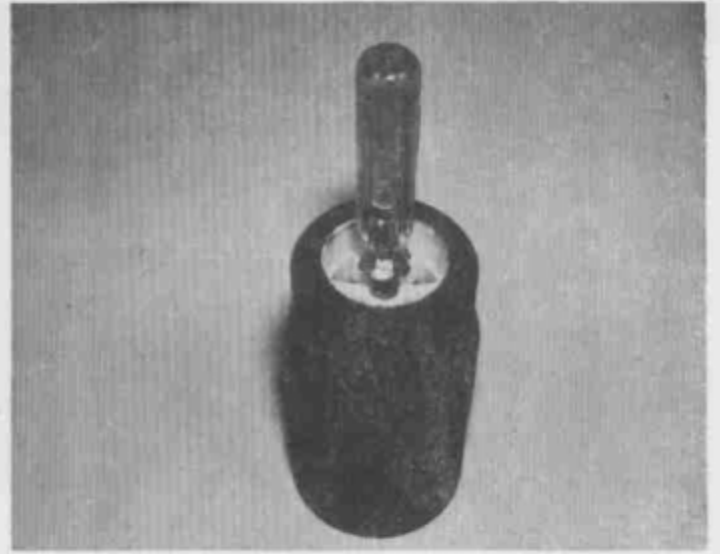

Fig. 20

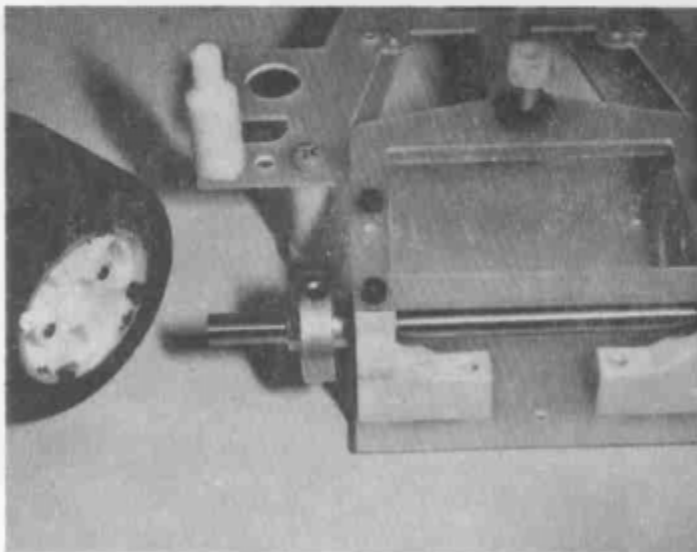

Fig. 21

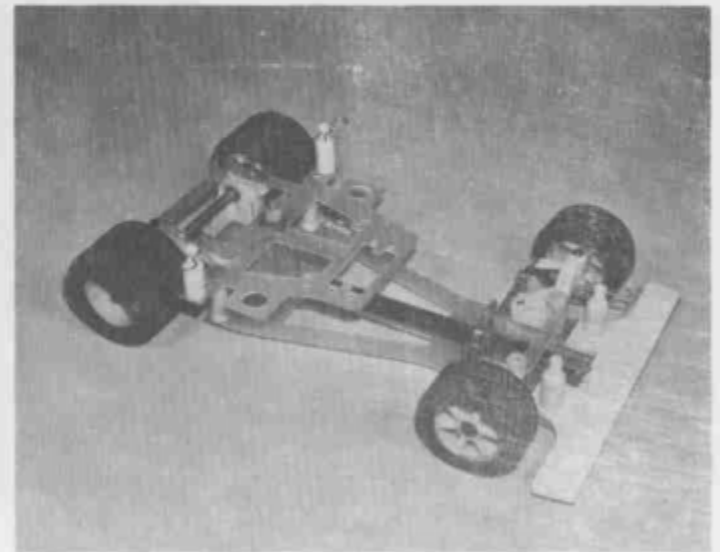

Fig. 22

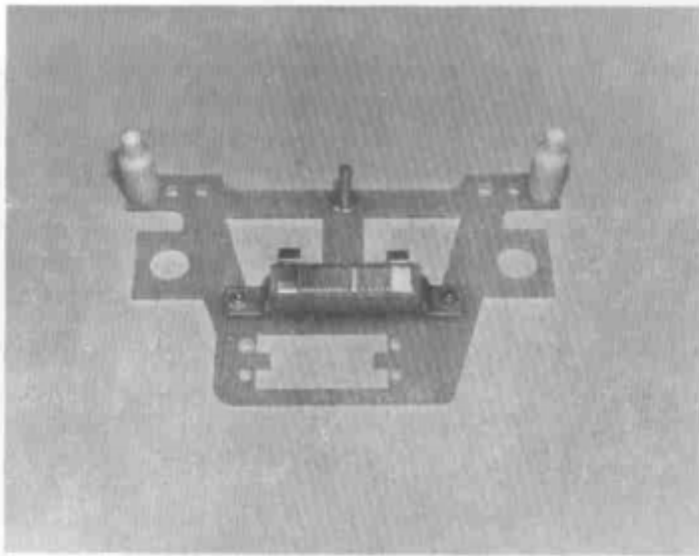

Fig. 23

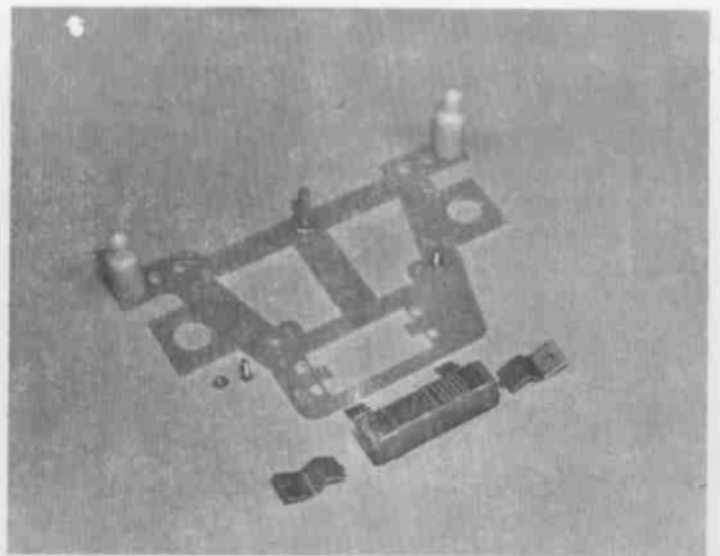

Fig. 24

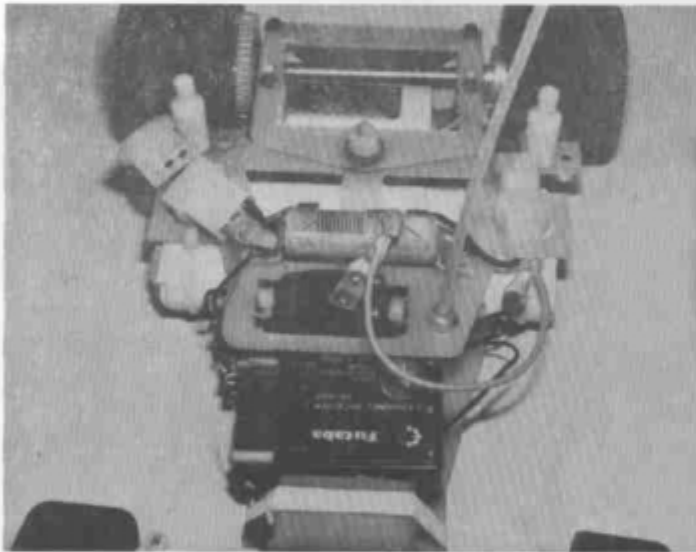

Fig. 25

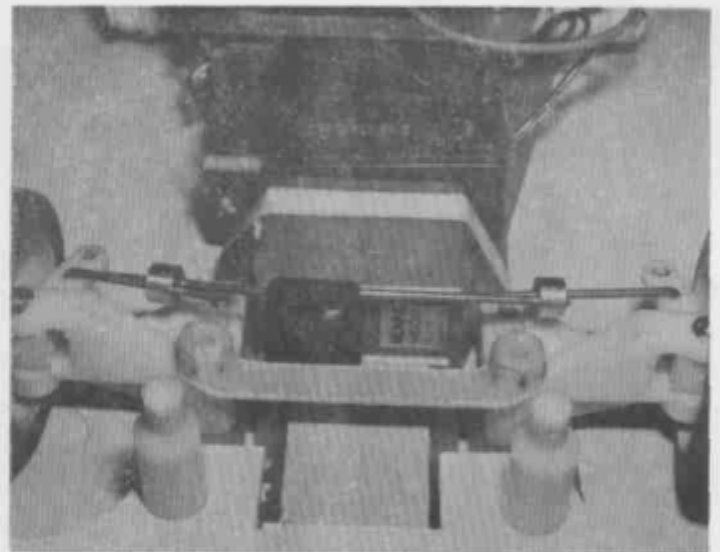

Fig. 26

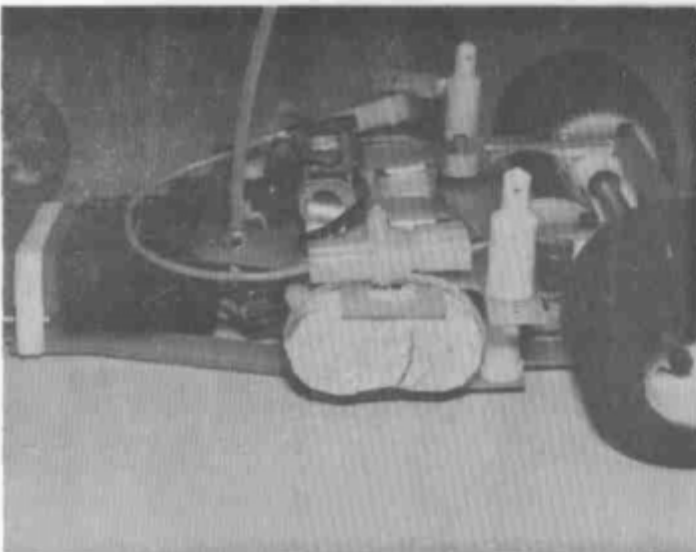

Fig. 27

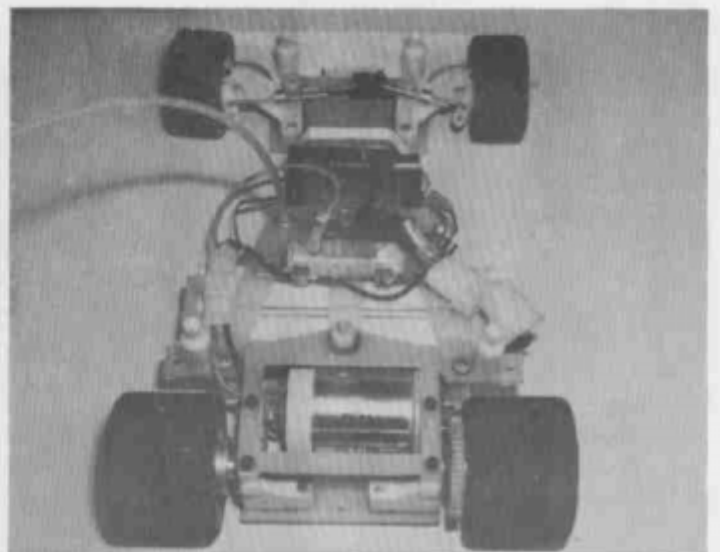

Fig. 28

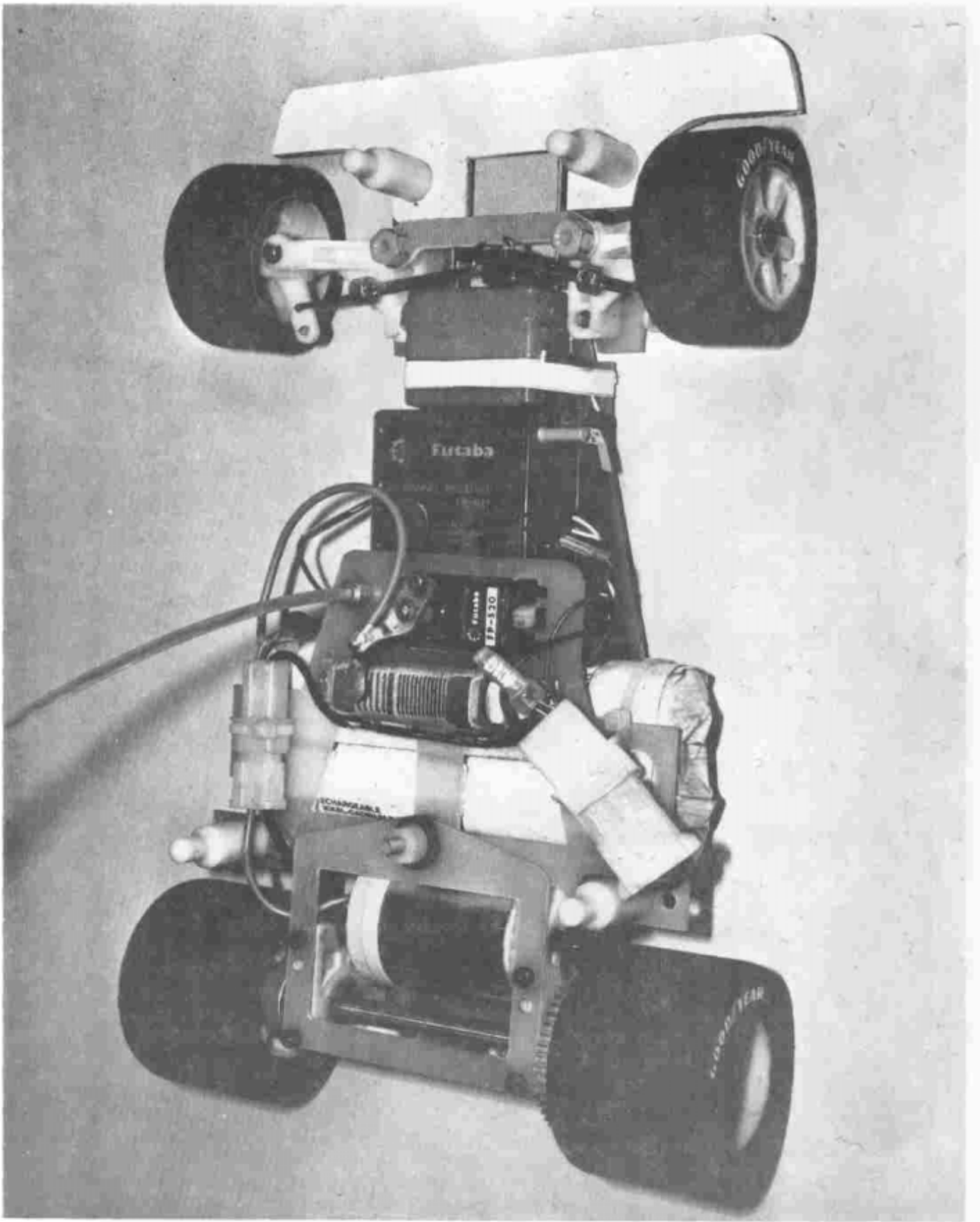

Fig. 29

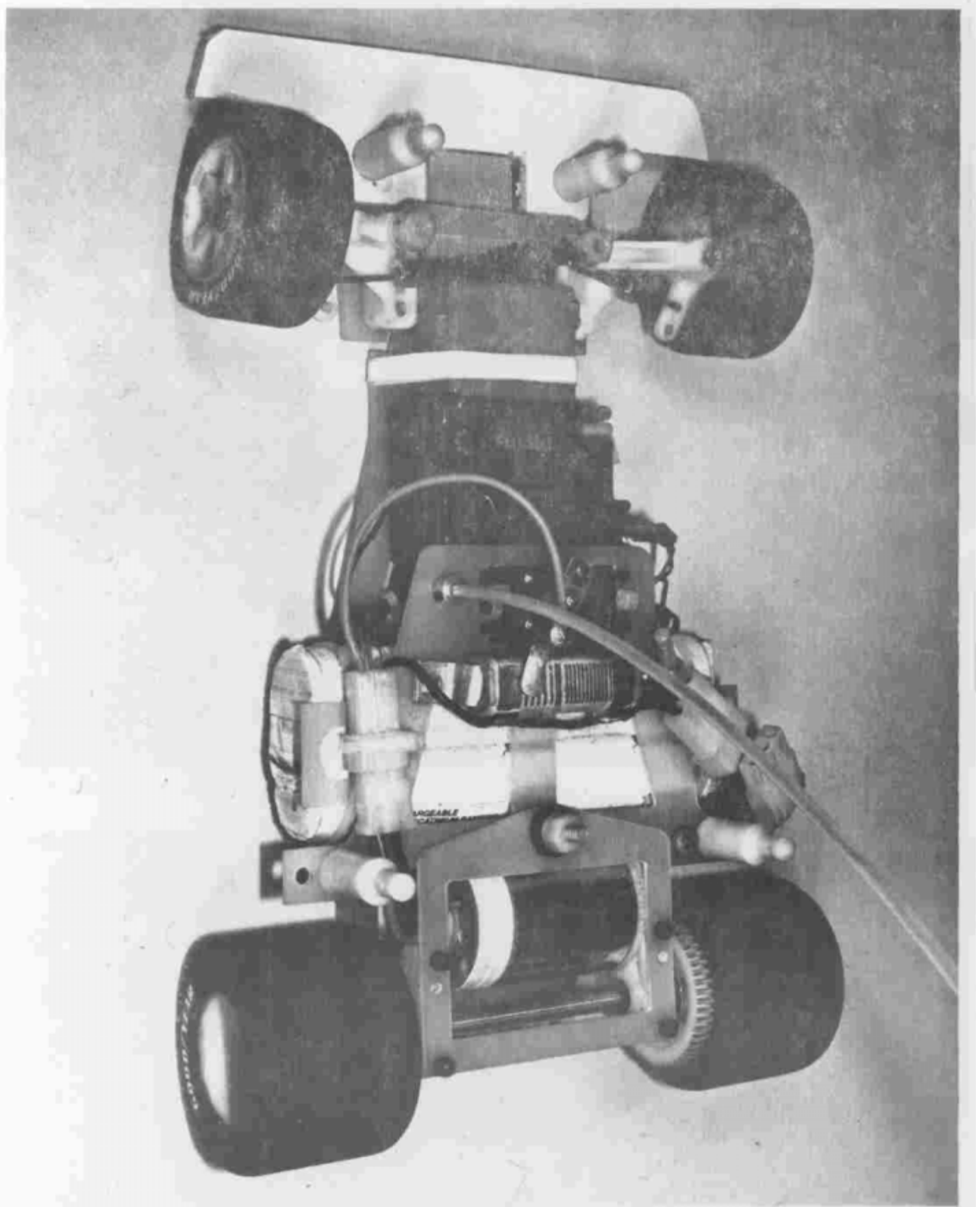
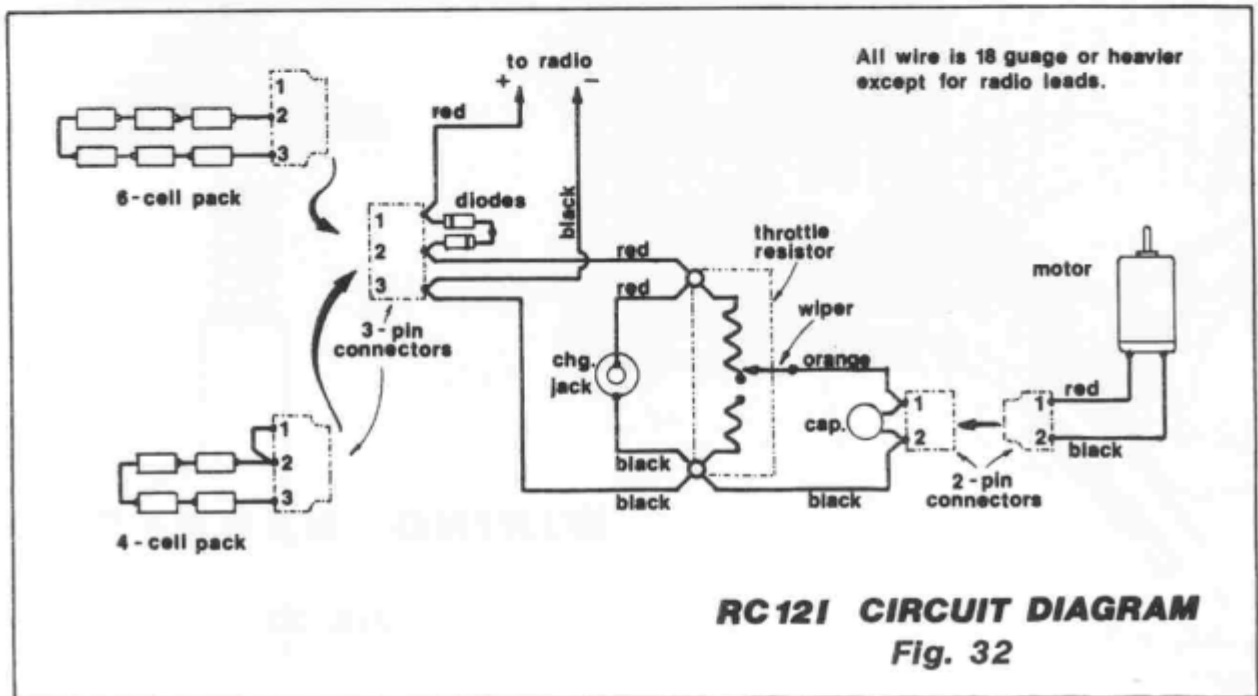
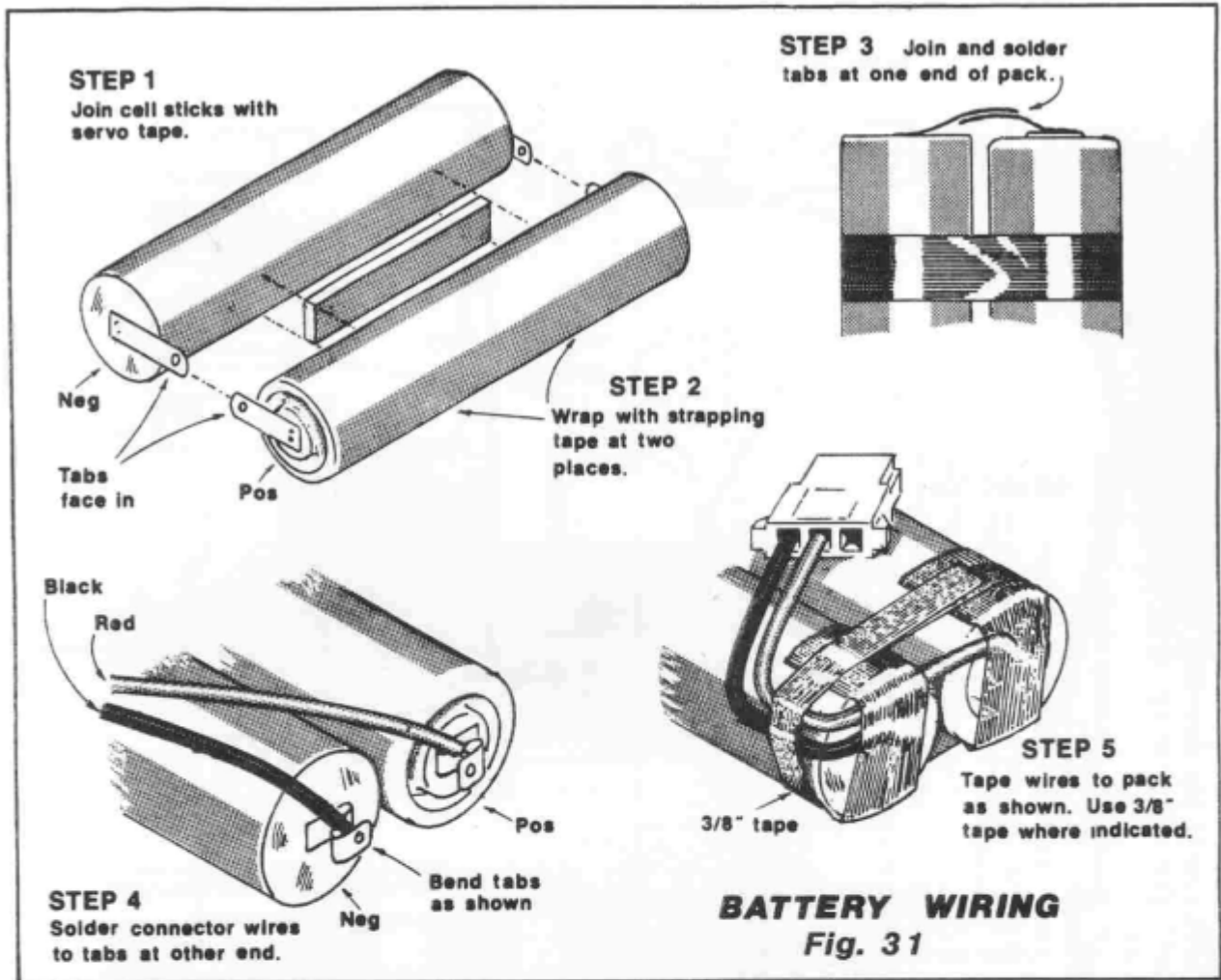
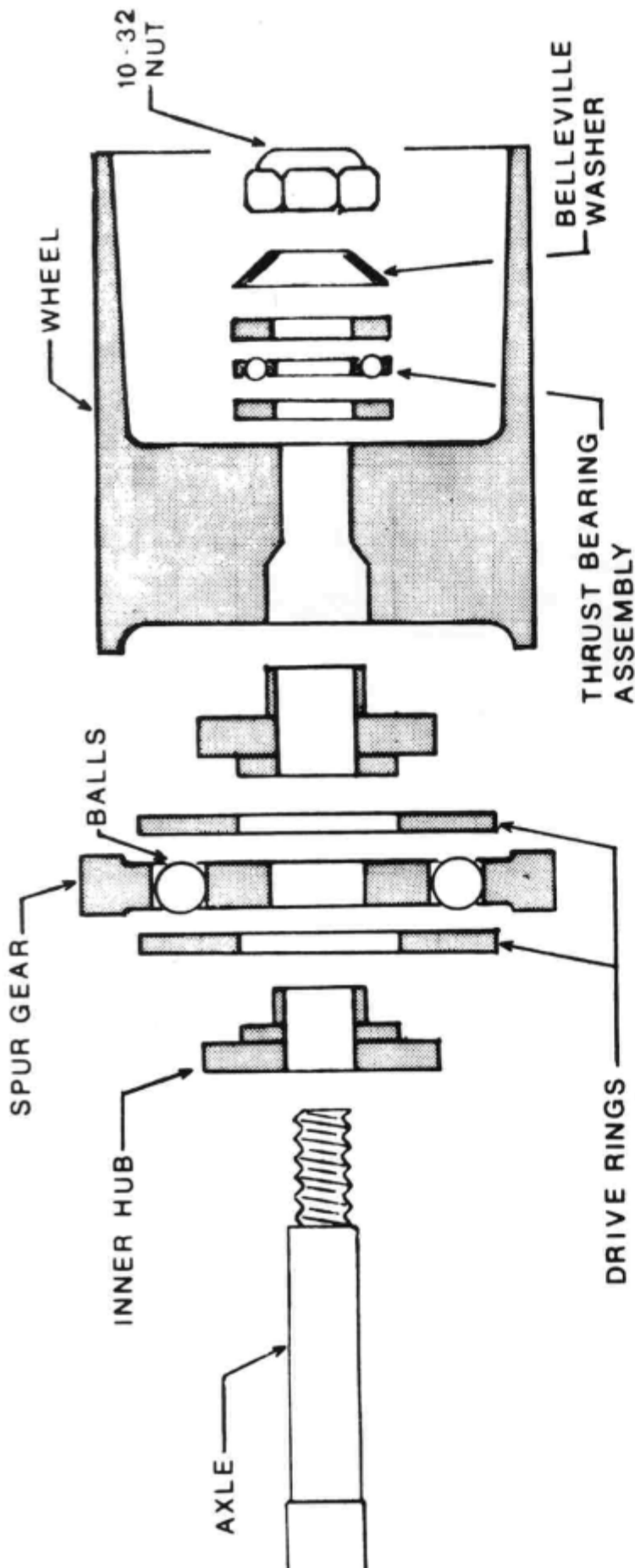

Fig. 30





PARTS LIST

- 3425 Spur gear, 44 tooth
- 3426 Spur gear, 46 tooth
- 3427 Spur gear, 48 tooth
- 3430 Differential, complete w/special tube axle, hub, rings, carrier, gear and balls, thrust bearing, Belleville washer, shims, and locknut. Unit replaces standard axle and right-hand wheel hub. Uses standard wheels.
- 3431 Rear axle for differential, tubular alloy steel; with differential hub, stud, shims, and Belleville.
- 3432 Ball set for differential
- 3433 Drive ring set; 2 hardened and ground rings and one aluminum ring carrier.
- 3434 Thrust ball bearing, 1/4" ID x 9/16" OD, for differential (one req.) or as rear thrust for non-diff setup (2 req.).
- 3435 Belleville washer and shim set.

Fig. 34

"FOUR-POST" Radio Tray Mount

The latest production runs of the 12i chassis and radio trays include holes to allow two additional mounting posts to be used in front of the battery pack (see fig. 1). Use flat head screws to mount the posts to the chassis, and round head screws in the radio tray. These two top screws should be left slightly loose (about one turn) to prevent "tweaking" under heavy impact.

The 4-post arrangement makes it unnecessary to servo tape the battery pack to both the radio tray and chassis. A small amount of servo tape can be used under the radio tray to keep the pack from sliding around, and the pack can then be secured to the radio tray with a wrap of strapping tape or a nylon tie wrap at each end.

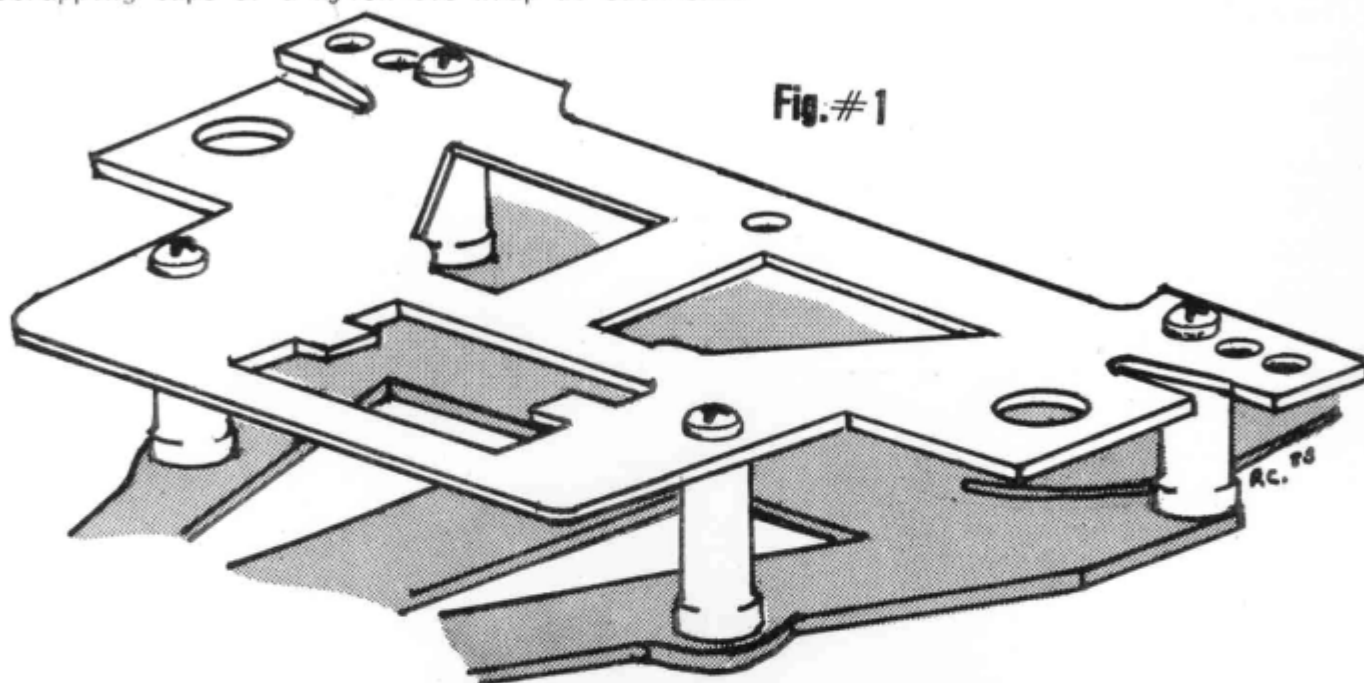

FRONT BRACE

The fiberglass cross brace for the front end (cat #4120) should not be tightened down firmly with the mounting nuts. These nuts should be left slightly loose to prevent tweaking of the front end under impact.

UPSIDE-DOWN Front Linkage

Racing experience with the 12i has shown that steering precision can be improved by mounting the servo saver to the servo upside down. It will be necessary to space the servo about 1/4" above the chassis with a small platform servo taped to the chassis. The platform can be made of any lightweight rigid plastic such as fiberglass or bumper material.

The linkage tie rods have to be bent as shown in Fig 2 to clear the suspension arm mounting pads.

This upside down configuration uses a normal servo rather than a reverse servo as indicated in the 12i instruction manual.

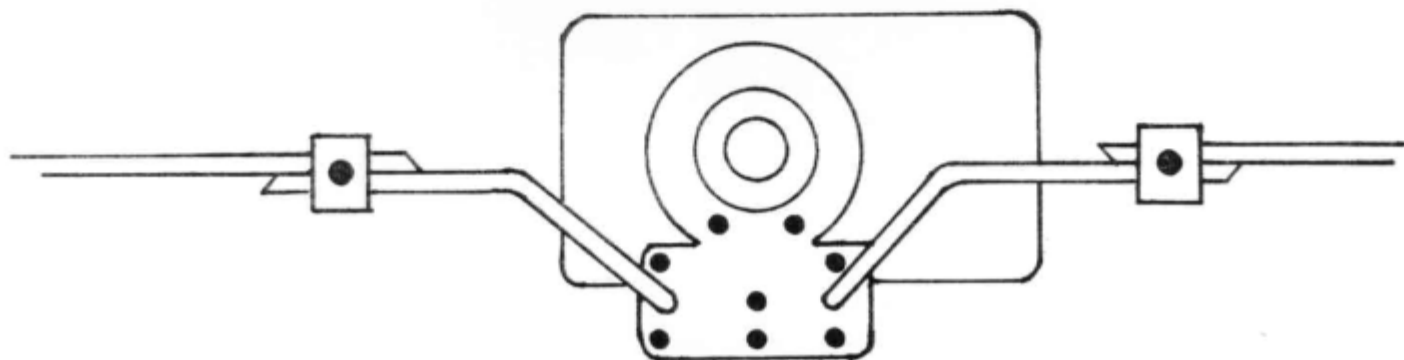

CHASSIS LEVEL