

TEAM ASSOCIATED

RC 12L INSTRUCTIONS

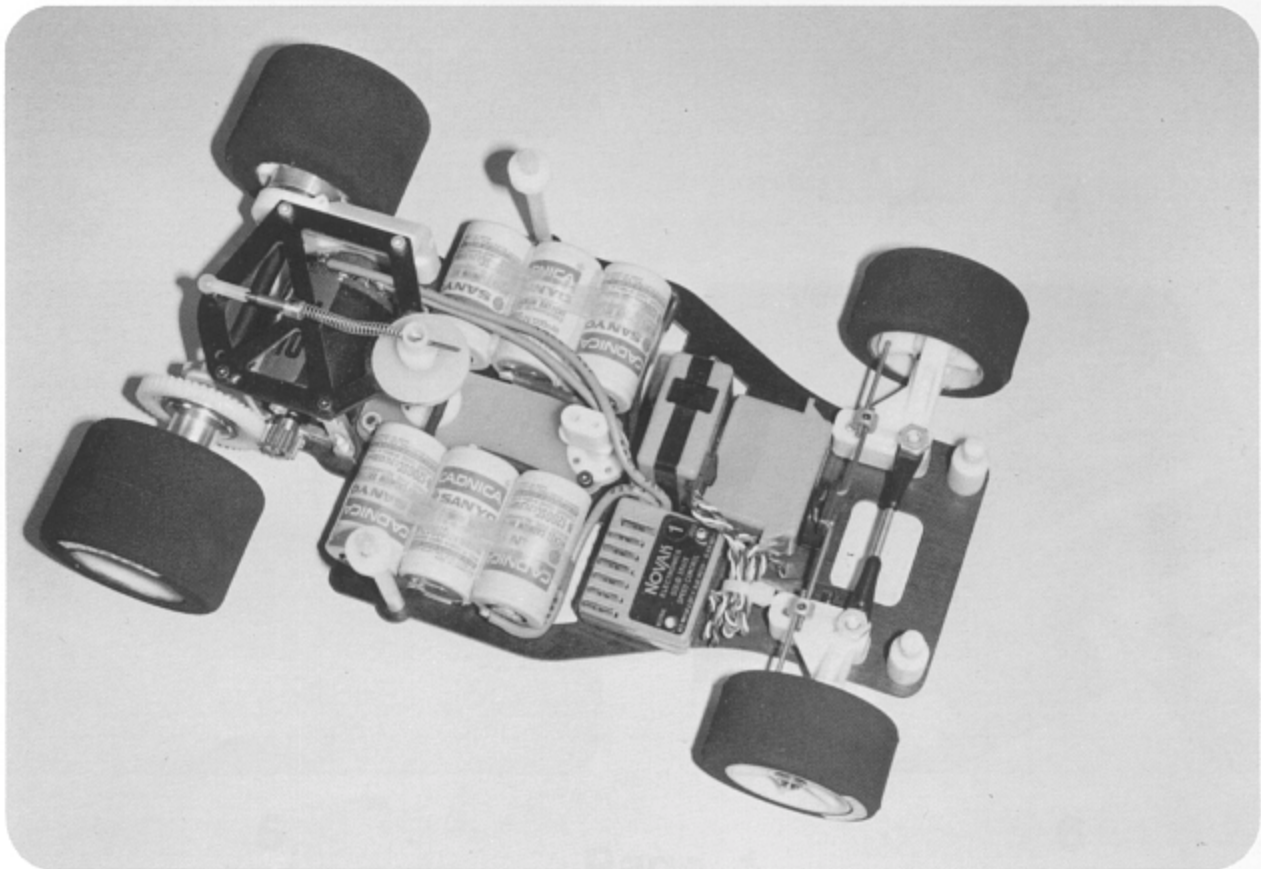

**RC12L
ASSEMBLY INSTRUCTIONS**

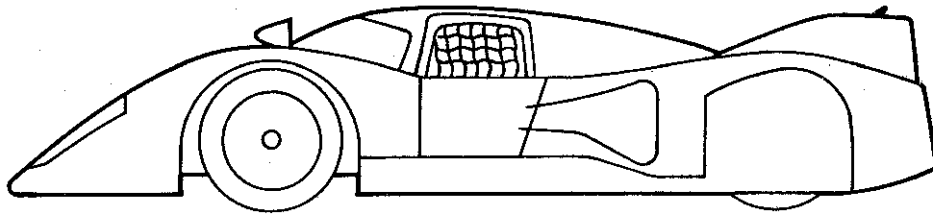

TA TEAM ASSOCIATED

CAUTION

Ni-cad batteries are susceptible to damage when overcharged at a high rate, and can release caustic chemicals if the overcharge is severe. Read the battery charging instructions in this manual before attempting to run your car.

Do not stall the motor under power. If the car stops suddenly on the track, or fails to move forward when you attempt to accelerate, push the throttle control on your transmitter to the brake position immediately and attend to the car. A small rock can stall the gears, and if the throttle is left in the on position the result can be a burned out motor or resistor (or electronic speed control unit).

If you run your car to the point where more than one cell in the pack is completely discharged, it is possible to lose radio control of the car before the drive motor stops completely. For this reason you should not operate your car in an area where it could be harmed or cause harm, such as near a busy roadway or a pool of water. Usually radio control will be regained as soon as you pick up the car and the motor is allowed to free-run. If you still don't have control, then you should unplug the motor.

A partially burned-out or shorted motor can make the car appear to have radio problems. If the car slows down suddenly and the radio acts erratically even with a full battery charge, then the cause is probably the motor. Check the range of the radio with the motor unplugged. A shorted motor will draw extremely high current even under no-load conditions.

RC12L ASSEMBLY INSTRUCTIONS

CONGRATULATIONS!! You now have the best 1/12 scale car in the world! The RC12L has followed along in the winning tradition of all Associated 1/12 cars. Starting with the original RC12E, which won numerous National Championships, Associated then designed the RC12i, which won the very first 1/12 World Championships in Anaheim, California, and then again won the next World Championships in Denmark.

The RC12L has followed in this winning tradition, by taking 1st, 2nd, 3rd, and 5th at the World Championships in Las Vegas, Nevada, thoroughly dominating the race, including Top Qualifier honors, against the best cars and drivers from around the world. We think you'll be pleased with the car.

The original design of the RC12L, incorporating the ball pivot joints on the T-bar, came from Gil Losi Jr. Gil built the first prototype cars and proved their racing ability. With Gil's participation, Associated further developed the car to its present state of performance.

ASSEMBLY - To eliminate confusion, do not open any of the parts bags until we tell you. Otherwise you will mix up small washers, screws, springs etc, which will make assembly much more difficult.

We also recommend using a paper plate to hold the parts from each bag in. One bag into one plate only, etc. This will keep the parts from each bag separated and will prevent any parts rolling off the table onto the rug and being lost forever. It actually happens.

You'll find the photos in the instructions are so easy to follow, that many of you may be tempted to put the car together from the photos alone. However, although you have the best car kit, if you want the best completed model race car, then you will want to put it together correctly, using these instructions. Take your time. The better you assemble the car, the better race car you will have.

PHOTO #1 - Take bag #1 and empty it out on a paper plate. Now turn to Photo #1 in the photo instruction book. Take one of the #3213 front axles and push in one of the #3214 "E" clips into the axle groove. The "E" clips are taped together and can be seen a little better in photo #3. Put another clip on the other axle. Now we'll want to tap the axles into the #3211 front steering blocks in the direction shown. The axle will go in tight, so support the steering block before driving the axle in. You can use a board with a small hole in it, or a vise. Set the block on top of the vise and drive the pin

downward thru the slightly opened jaws. Do both blocks. Now use a pencil and put a checkmark by this #1 instruction to show it's completed. Do it with each instruction as it's completed.

PHOTO #2 - Your front blocks should look like this.

PHOTO #3 - Now we're going to assemble the steering blocks into the #4115 front suspension arms as shown in photos 3 & 4. Slip the steering block in the arm, as shown, place a spring on top of the arm as shown. **NOTE:** There will be a pair of #4119 soft springs and a pair of #4118 firm springs in the kit. Use the soft springs if you race on carpet, and use the firm springs for asphalt. Now we have to put an "E" clip into each of the 2 grooves in the kingpin. It's easier to put the clip by the spring in first, and then to put the clip on the bottom of the steering arm last. It will be a close fit but it will go. Make sure it's securely in the groove. Pushing it in with a small screwdriver seems to work best.

PHOTO #5 - We'll do this step later, do not check it off yet.

PHOTO #6 - Look at photos #6 and #64. We want to file the upper edges of the chassis as shown, so that the bottom of the batteries will be even with the bottom of the chassis. **PLEASE NOTE:** The photo shows a graphite chassis, but these instructions are for both the fiberglass and graphite RC12L cars, so do step #6 for whichever chassis you have. Lightly file both of the upper edges of the slot until one battery cell will fit flush with the bottom of the chassis. Do all 6 slots.

Now in photo #64 look where the strapping tape goes around the chassis to hold the batteries in. We also want to lightly file the corners of the chassis where the tape goes, so the sharp edges of the chassis cannot cut the tape. Take a paper towel and thoroughly wipe off the chassis clean, and then wash your hands thoroughly.

PHOTOS #7, #8, #9 - Your kit comes with 2 different T-bars. A thick - .074 and a thin .062 one. The photo is showing the thick one, which should only be used on extremely high traction surfaces. Take the #4330 thin T-bar out of bag #2. We suggest you start with the thin one for carpet or asphalt tracks. Using Photos 7-8-9, place one of the #4336 pivot balls between the 2 #4335 plastic pivot ball plates, as shown, and install the 4 Allen screws. Do not over tighten. The ball may be a little tight in the plastic, but in this location that's good.

PHOTO #10 - At this next location, the ball **MUST BE VERY FREE. NOT LOOSE**, but there must not be the slightest amount of any bind whatever. To start with, take a XXXXXXXXXX knife, as shown, and very lightly smooth up the inside

of the large hole, as shown. Slip one half of the plastic ball cup in the hole. It should go in very, very easily. Like if you could push it in with your tongue, but again, it should not be loose.

Install the ball, the other half of the plastic cup and the 4 screws. Now see if the ball is **PERFECTLY FREE**. If it is, good, leave it alone. If it's not, there are 2 things you can do. You can unscrew all 4 screws one half turn. But the best thing to do would be to take the ball back out and polish it up. You can do this by placing a 4/40 screw in the ball and securing it with a nut and turning the screw in a drill press. Then polish the ball with crocus cloth or #660 wet or dry sandpaper. Re-install the ball and make sure it's **PERFECTLY FREE**, but **NOT LOOSE**.

PHOTO #11 - Your T-bar should now look like this.

PHOTOS #12, #13 - Take the 2 long flat head black Allen screws, slip them up through the bottom of the chassis and set the T-bar on the screws. Now, where the ████████ blade is pointing, place a pencil in these 2 holes and mark the chassis.

PHOTO #14 - We need to put a thin steel shim in the 2 locations shown here. You can use steel shim stock, or even steel from a tin can, but not aluminum. This is to prevent the 2 chassis tweak screws from digging into the chassis. A better idea than using the 2 separate pieces, as shown in the photo, would be to use a piece 1" long, and drill a 4/40 clearance hole in the middle of it. That way it would be bolted to the chassis under the ball socket. Use a contact type glue to hold the shims in place, but do not use **ZAP**.

PHOTO #15 - Looking back at photo #12, slip the 2 long screws back in the chassis. Take the one aluminum washer shown, and slip it onto the **FORWARD** screw. Now slip the T-bar down over the screws and install and securely tighten the 2 nuts.

PHOTO #16, #17 - Install the 2 Allen tweak screws in the T-bar as shown in 16. **BE CAREFUL HERE**. The screws will go in tight. **DO NOT OVERTIGHTEN**. The 2 tweak screws should be screwed in **EXACTLY** the same amount, and they should **JUST TOUCH** the shims you glued on. If you overtighten these screws you can pop the ball right out of the socket.

Now look at photo 17. Check the gap between the chassis and the rear of the T-bar. This gap should be even all the way across. If it's not, loosen up the tweak screw on the high side and then tighten the other tweak screw exactly the same amount. Tighten just enough to take the play out of the front of the T-bar but **DO NOT OVERTIGHTEN**.

PHOTO #18 - Open bag #4. One end of the #4337 aluminum tube will be threaded. Screw this down tight on the rear screw, as shown, and screw the #6338 antenna mount on the other screw.

PHOTO #19, #20, #21, #22 - Open bag #3 OR 9. If you have the fiberglass kit, install the #4322 lower bracket to the #4345 LH and #4346 RH bulkheads, as shown, with the 6 aluminum screws. Do not overtighten.

If you have the graphite kit, install the #4325 lower bracket to the #4345 LH bulkhead with the 3 aluminum screws. Do not overtighten. Install the RH aluminum motor mount bulkhead next. Place a drop of oil on the aluminum screw before you install it, and then install the other Allen screw.

PHOTO #23, #24 - Now we'll install the T-bar onto the rear end. Place the 3 flathead Allen screws up through the bottom of the bottom bracket. Now slip 2 aluminum washers onto each screw. Now slip the T-bar down over the screws. The washers should now be between the lower bracket and the T-bar. Put the locknuts on and tighten securely.

PHOTOS #25, #26 - From bag #4 take one of the plastic collars shown, and install a set screw in it. Slip it on the aluminum tube and let it fall to the bottom, we'll adjust it later. Now slip a spring on the tube and then the larger plastic washer with the flat side up.

PHOTO #27 - Take the upper bracket, whether it's graphite or fiberglass. We need to smooth all the edges near the big hole, where the aluminum tube comes up through in photo 28. The bracket has to be able to slide **VERY FREELY** between the plastic washers. So sand all of this area with #600 wet or dry sandpaper so there are no sharp edges or ridges, top and bottom. Wipe off the bracket and wash your hands.

From bag #4 install the steel ball onto the #4324 graphite or #4321 fiberglass upper bracket, as shown, with the Allen screw.

PHOTO #28 - From bag #3 OR 9, if you're using the fiberglass upper bracket, use 4 aluminum 4/40 screws and install the bracket. Do not overtighten. If you have the graphite kit, **ONLY** use the 2 aluminum - light colored - screws in the LH bulkhead and the 2 steel - dark colored - screws in the aluminum bulkhead, as shown.

PHOTO #29 - Hold the chassis and rear end flat down on a table and lift the locking collar up the aluminum tube until the spring is half compressed, and tighten set screw. Now install the upper large plastic washer, spring and #4342 upper collar. While holding the chassis and rear end flat on the table, push down on the upper collar until the spring is half compressed, align the hole in the collar to go from front to back and tighten down on the set screw.

PHOTO #30 - From bag #4 solder the piano wire into the threaded brass tube end.

PHOTO #31 - Screw the plastic end on the brass as far as possible. Slip the metal collar with set screw all the way down onto the piano wire. Now put a small "S" bend in the piano wire so it can move more freely through the hole in the plastic collar. Slip the spring on the wire, and slip the wire through the hole in the collar and snap the plastic ball cup onto the ball.

PHOTO #32, #33 - Now we'll put the differential - or diff - together, with the parts in bag #5. Take the #4355 diff axle and #6625 diff washer and slip the diff washer onto the alum diff hub, as shown in photo #33. We want to use a cyanoacrylate adhesive, such as pink ZAP to glue the washer on. Hold the washer as tight as possible against the aluminum shoulder and then put a very small amount of this adhesive, using the end of a XXXXXXXXXX knife, or a small screwdriver, between the washer and aluminum hub shown in photo #33. Allow to dry for 15 seconds, and then release your hold.

PHOTO #34 - Take the #3427 plastic spur gear and push 8 of the steel balls into the gear. Put a small amount of Associated diff lube #6636 onto both sides of each ball, and also a little on the center hole of the gear.

PHOTO #35, #36 The parts go on the axle in the order shown. The gear goes on the axle next and then the other large steel washer. However, it will be easier to glue the second large steel washer onto the #4359 wheel spacer first. So seat the washer on the lip of the spacer, hold it tightly and apply a thin bead of cyanoacrylate adhesive, and wait 15 seconds.

Now push the #4360 plastic bearing holder into the wheel spacer and push one #897 ball bearing into the bearing holder.

PHOTO #37 - Now slip the wheel spacer onto the axle.

PHOTO #38 - Now slip the wheel/tire onto the axle.

PHOTO #39 - Install the parts, in the exact order as they're shown in 39 onto the axle. First, push one #897 ball bearing onto the axle and into the wheel. Then slip the #3434 thrust bearing on, the thrust bearing washer, the #3435 coned washer and then the #3438 locknut. Just tighten the locknut enough to take out all the play right now. We'll make the final diff adjustment later.

PHOTO #40 - The RH side of the diff should look like this.

PHOTOS #41, #42 - In bag #3 OR 9 there are 3 pair of different axle bearing holders, #4348, #4349 and #4350. Take the pair that mounts the bearing right in the center. Photo #42 shows the order that the parts go onto the axle. The flat steel washer, the thrust bearing, the ball

bearing and then the bearing holder. It would actually be easier to put the bearing holder into the #4346 or #4347 RH bulkhead first, see photos 19 & 21. Push the bearing holder into the bulkhead, then push the bearing into the bearing holder and put the other bearing holder and bearing into the #4345 LH bulkhead. Install the axle into the bearings.

PHOTOS #43, #44 - The bearing holder and bearing should already be in the bulkhead, so now slip the thrust bearing and washer onto the axle.

PHOTO #45 - Start the set screw into the #3613 wheel hub and then attach the LH wheel to the wheel hub with the 2 Allen screws, as shown.

PHOTO #46 - Put the wheel on the axle and tighten down, **JUST A LITTLE BIT**, on the set screw. Then take the wheel back off, and slip the axle back off the car. On the axle will be a mark where the set screw touched the axle. As shown in the photo, file a small slot in the axle for the set screw to seat on. Then put the axle, bearings etc. back in the car. Now slip the LH wheel on and screw the set screw in so it just barely touches the axle and back it off 1/2 turn.

Now we need to set the side play in the axle. This would be the amount of play, that if you held the rear of the chassis in your left hand and then took hold of the RH tire with your right hand and tried to slide the axle from side to side. This side play must be set so that there is some side play present. If there is no side play whatsoever there will be too much drag which will shorten your run time. Try to set the end play so there is about .010, maybe about the thickness of a coke can. Then tighten down on the set screw in the LH wheel. Double check your end play again. You **MUST** be able to feel a small amount of end play. Then if you spin the rear end, it should spin for quite a long time.

PHOTOS #5, #47, #48, #49 - Now we're going to install the front end. The #4127 spacers come in flat and tapered shapes. Install one flat and one tapered shim under the suspension arm so that the front of the arm is higher than the rear. This will give the front end 2 degree caster.

Install the RH suspension arm, as shown in the photos, using the longest screw in the front and the next longest in the rear of the arm.

Install the LH suspension arm.

Also in bag #1 are 2 black plastic rod ends and a threaded rod. This is part #4327. Screw the rod ends onto the threaded rod just far enough so that the rod ends will easily slip down onto the 2 forward screws in the suspension arms, and then install and tighten the 2 nuts.

In photo #47 install the two #3320 front body mounts, as shown.

PHOTOS #5, #50, #51 - In photo #5, the pointer is pointing to a small nylon washer. Slip this washer over the axle.

If you have the fiberglass kit, push the brass wheel bushing into the wheel from the inside, place a few drops of oil on it and slip it on the axle.

If you have the graphite kit, install 2 ball bearings in each wheel and slip the wheels on the axles. Now slip another nylon washer on the axle and then an "E" clip. The wheels should spin freely.

RADIO GEAR - Front cover photos, 48, 49, 52 and 53. The RC12L is designed as the latest state of the art, 1/12 scale model race car. It requires the use of the latest state of the art radio equipment, such as mini servo, mini receiver and mini electronic speed control.

It's very difficult for us to recommend one particular type of radio equipment over another. There's quite a few very good radio systems being made, and many which are just not good enough. And improvements are being made continually. Let me just tell you the radio equipment that the World Champion, Tony Neisinger chose. The Futaba Magnum transmitter, the Futaba S32SH servo, Novak receiver and Novak speed control. There might be other equipment as good.

Check out all the photos showing the radio installation very carefully. Then take your own radio gear and lay it out on the chassis so that it is like the photos. Make sure everything clears and that there is room for the batteries. Make sure you can get to your receiver crystal. Mark the chassis where the parts go.

Now, install the servo first. Take the roll of black servo tape and stick it to the bottom of the servo and then install the servo to the chassis with the tape. Then install the speed control flat on the chassis with the receiver standing up.

Cover photos 49 and 53 - Next we'll install the #4126 tie rod assembly. First, remove the steering arm from the servo and slip on the Kimbrough servo saver #3761, but do not install the attaching screw yet. You'll have to reposition the servo saver after your radio is hooked up.

You may have to slightly enlarge the holes in the servo saver and steering arms so that there will be no bind in the tie rods. Set the lengths of the tie rods so that the wheels are pointing straight forward. Tighten the 2 set screws.

Now take hold of the set collar and see if you can twist or rock the tie rod a small amount. If the tie rod feels tight then you **MUST** open up the holes in the servo saver and steering arms a little more.

Cover photos #63. Install the #4329 rear body mount as shown. Push the silver slotted screw up through the chassis. Take one of the

plastic tubes, which will be installed with the cross drilled body clip hole, up. Now slip one of the plastic collars on the bottom of the tube and screw the screw into the tube all the way. Now tighten the set screw in the collar.

Now install the upper collar about .100 below the body clip hole and tighten the set screw. The rear of the body will rest on this collar.

BATTERIES - Photo 59, 60 and 61 - The batteries will be assembled as shown in photos 59, 60 and 61 **ONLY**. **DO NOT** attempt to assemble them from any of the other photos. They're only to show basic steps.

Photo #54 shows you the negative end of the battery, to the left, and the positive end of the battery on the right. These markings are also on the batteries.

The batteries will have to be fastened together, as shown in photo #54. You can use the cyanoacrylate adhesive, or you can put a small amount of baking soda, as shown in photo #54 between the cells and then put the cyanoacrylate adhesive on the baking soda. This makes an incredibly strong bond. Or you can use Hot Glue or Contact cement.

PHOTOS #59, #60, #61 - Glue 2 sets of 3 cells each together, as shown in 59, 60 and 61. Make sure the solder tabs are all pointing straight up, as in photo #54.

PHOTOS #55, #56 - Cut 4 pieces of wire out of the single piece of wire in the kit, as shown, long enough to cover both soldering tabs. Strip the insulation off both ends, as shown.

PHOTO #56 - Now using 60-40 rosin core solder, solder the wires to the 2 tabs as shown. **NEVER USE ACID CORE** solder on wiring. Now cut the excess tabs off, as shown. The 2 cells you just soldered together are the same as cells #6 & 5 in photo #60.

PHOTO #59, #60, #61 - Now, finish soldering up the battery pack as shown in photos 59, 60 and 61 only.

PHOTO #61 - Hook up the wires with the connector plug on, so that the red-positive wire goes to the positive terminal on battery #1.

Hook up the black or blue negative wire to the negative terminal on battery #4.

PHOTO #62 - This diagram shows the rest of the wiring hookup. The plug with the 2 wires going to it will be plugged into the motor plug. The plug with the 3 wires going to it, will be plugged into the battery pack, but **NOT UNTIL THE CAR IS READY TO RACE AND NOT BEFORE**.

PHOTOS #63, #64 - We'll attach the battery pack to the chassis using strapping or filament tape **ONLY**, which is available in any hobby, hardware, or supermarket store.

Set the batteries down into the chassis

slots. Cut a piece of tape at least a foot long. Stick one end of the tape on a piece of lexan or sheet metal about 1/2" wide by 3" long. It's much easier to thread this metal through the slots of the chassis rather than trying to thread the tape through the chassis. Tape the batteries in as shown.

PHOTOS #65, #66 - You can install and remove the motor in the car by coming up through the bottom of the rear end.

If you have the aluminum RH motor mount bulkhead, as shown in photo #65, **DO NOT** use the long motor mount screws, they can damage the motor. **ONLY** use the short screws. The long screws are used with the plastic bulkhead.

Before you tighten down on the screws, you might have to trim just a little bit of the lower graphite bracket, by the aluminum bulkhead, where the bottom of the motor hits the graphite.

After clearancing the graphite, adjust the motor so that there is just the very slightest amount of play between the plastic diff gear and the steel motor gear. If this is too tight you'll lose a lot of power.

FRONT COVER, #57, #58, #67, #68 - HARD WIRING - This means to make all the wire connections by soldering, without any plugs. This is used and recommended for experts, but **IT IS DEFINITELY NOT RECOMMENDED FOR BEGINNERS**. This can get you in a lot of trouble fast if you don't know what you're doing.

SPEED CONTROLS - We cannot show you the wiring hookups for speed controls, because each manufacturer is different. If you look at photo #62 you'll see that there are 3 wires going to the speed control. These would be connected as per the speed control manufacturers instructions.

The upper 2 wires are black-negative and red-positive from the battery pack, and you should be familiar with those 2 wires. The third wire is black for the motor negative wire to the speed control. The other motor red-positive wire goes to the wiring plug and then to the battery pack. If your speed control has 2 separate motor wires from the speed control, then you will have to cut the motor red-positive wire by the battery plug (not the motor plug) and connect it to the speed control.

Wherever you make these solder connections from the wiring harness to the speed control make sure you tape them up with electrical tape, otherwise you'll short out the wires and burn up your radio. Wire up your radio and speed control per manufacturers instructions.

Install the antenna tube into the #6338 - photo 18 - antenna mount and feed the antenna wire up through the tube.

BATTERY CHARGING

There are many good ways to charge batteries. Most racers now will use one of the many automatic chargers on the market. Whatever charger you use, simply plug it into the plug that the arrow is pointing to in photo #61 and charge per instructions.

CHARACTERISTICS OF Ni-Cd BATTERIES

It is important to understand the characteristics of the battery pack in your car because how you use it will greatly affect both its performance and life. With proper care your pack will give you top performance for many hundreds of cycles.

The R.O.A.R. legal battery is composed of either four or six "sub-C" size cells with a maximum rated capacity of 1.2 amp-hrs. This means that the cells will supply 12 amperes for one hour, or 0.6 amperes for two hours, etc. This capacity rating drops to about 1.0 amp-hrs. at high drain rates. For instance at six amperes (a typical average current drain for an electric car) the cells would discharge in 1/6 of an hour or ten minutes. This charge capacity is the same regardless of the number of cells in the pack because the cells are connected in series and the same current passes through each one. In other words, the charge capacity of a four pack is the same as a six pack. The total energy storage of a six cell pack is higher, of course, because the voltage is higher.

Ni-Cds are very efficient and they give back almost as much charge as you put in, as long as you don't try to put more charge in than they will hold. If you start with a completely dead pack and charge at four amperes for 1/4 hour, you will have put a total of one amp-hr (4 x 1/4) into the cells. More than 95% of the charge would be recovered if the pack were then discharged at the one hour rate.

OVERCHARGE

There is no way to make a Ni-Cd cell accept more charge than it is designed to hold. This means that the charging efficiency begins to drop off as the cell approaches a fully charged condition; and the portion of charging current not being stored becomes heat and pressure. If charging continues after the cell is fully charged, all of the current is converted to heat and pressure - about 40 watts worth - or the equivalent of the heat produced by a medium sized soldering iron.

HEAT AND PRESSURE

Either excessive heat or excessive pressure is harmful to the cells; and getting rid of one doesn't help the other. For example, cooling the battery with a fan while it's being overcharged will do nothing to stop the pressure build-up.

Excessive pressure momentarily opens a safety vent in the cell and a small amount of electrolyte is lost in the process. Once such occurrence is not harmful, but frequent venting will permanently reduce the performance of the cell. Excessively high temperature can permanently damage the separators. However, high temperature also has temporary (and bad) effects that will be explained later.

Ni-Cd cells have a built-in process for recombining the accumulated gas (actually oxygen) produced by overcharge, but the process produces heat and takes a lot of time. If you overcharge your battery and it seems to take a long time to cool down, it's because this pressure reducing reaction is taking place. Once the gas is recombined the temperature drops.

A hot Ni-Cd pack cannot be fully charged. At 130 deg. F (a temperature uncomfortable to touch for more than a few seconds) the cells will only accept about 50% of a full charge. This doesn't mean that a fully charged battery will lose charge if it's heated; it just won't accept a new charge efficiently. For this reason it is always better to allow the battery to cool before charging. A fan is helpful to speed the cooling process.

CHARGERS

All fast-chargers do basically the same thing, supply a charging current of about 3 to 5 amperes. Where they differ is in the power source they use (either 12 volts d.c. or 115 volts a.c.), and in additional features. Associated Fast Chargers (#3772 and #6772) meet the basic requirements of a good charger with a timer to protect against accidental overcharge, an ammeter, slow-charge, and a discharge circuit. Some chargers have features like a built-in voltmeter, constant-current, voltage peak detection, or temperature sensing. Naturally the more features a charger has the more expensive it becomes.

HOW TO TELL WHEN YOU'RE CHARGED

One of the problems with Ni-Cds is their inherent voltage stability; the voltage of a fully charged cell is not much different from one that's about dead. For that reason several indicators, along with some common sense, are needed in order to get the most out of your

battery. The following is a list of indications you should use to detect full charge.

TEMPERATURE METHOD

This only works if you start with a cool battery pack. As the pack charges, frequently check its temperature by feeling the cells directly. As soon as you notice an increase in temperature stop charging. If the cells become too hot to hold on to, you are way overcharged. Let them cool.

TIMED CHARGED METHOD

This only works if you have confidence in the timing accuracy of your charger. Many chargers on the market only approximate a constant charging current; they may vary from six amps when you first start charging all the way down to two amps if the Ni-Cd pack is nearly charged and the voltage of the charging source (automobile battery) is low. If the charging current varies, it becomes difficult to estimate the average current. However, if your charger is reasonably dependable you can use the following method.

Cycle your pack several times using the "temperature method" above. After you run the car the last time let the pack cool. Charge again using the temperature method but this time keep track of the time required to reach full charge. Once you have established the time you can use it as a setting for the timer on your charger. To be safe use a setting about a minute less than what you established. This method allows you to charge without constantly monitoring the battery temperature.

If you charge a battery that is still hot from running, reduce the time about 20%. Then, after the pack has cooled, finish charging with the temperature method. The reason for this will be explained later.

VOLTAGE METHOD

As mentioned earlier, voltage is a poor indication of a cell's state of charge. The change in voltage from 10% charged to 100% charged is usually less than 0.1 volts per cell. In fact other things like temperature, current drain, and "cell memory" have a greater effect on voltage than the state of charge does. However, if current flow and temperature are held constant, it is possible to see the cell voltage gradually climb during the charging process. The absolute value of this voltage isn't much use, but how the voltage changes is an excellent indication. To use this method you will need a digital voltmeter or an expanded-scale voltmeter

capable of resolving 0.01 volts on the 10 volt range.

Connect the voltmeter across the Ni-Cd pack, preferably right at the cell terminals, or if that's not possible, across the terminals of the throttle control resistor. Don't try to read the voltage at the output of the charger because you'll end up reading the voltage drop through all the connectors and cables between the charger and the Ni-Cd pack; and that can sometimes mask the effect you're looking for. You should start with a Ni-Cd pack that is less than 1/2 charged. Connect your charger and begin charging at four amps. If your charger is adjustable set the current now, but don't try to change it later. A constant current charger is preferable here, but if yours gradually drops off during charge, that's okay; as long as it doesn't drop below three amps.

Watch the voltage as the pack charges. Notice that the voltage climbs rapidly at first, and then very slowly in the middle of the charging cycle. This voltage will most likely be in the range of 8 1/2 to 9 volts for a six cell pack and 5 1/2 to 6 volts for a four cell pack. As the pack approaches full charge, the voltage will begin to climb more rapidly; and as it goes into overcharge the climb will slow down and stop. This is where you stop charging at the point where the voltage stops climbing. If you left the charger on, the voltage would begin to fall as the pack went deeply into overcharge and started to heat up. The maximum voltage reached will probably be in the nine to ten volt region; the actual value is unimportant. Do not try to use a conventional voltmeter. Even a good qualify VOM with a large, taunt-band, mirrored-scale meter movement is not adequate; by the time you could see that the voltage had stopped rising, it would be too late.

SLOW CHARGE METHOD

Slow or "over-night" charging is a method you are not likely to use often. However, it is a good way to bring the pack to absolutely full charge.

The charging current must be between 0.05 and 0.12 amperes. Any less and the pack will never reach full charge; any more and the pack will overheat. The time required to reach full charge ranges from 15 to 40 hours depending on the current used. The charger can be left on for a much longer time without harming the cells, but the output voltage of the pack will be temporarily lowered by an extremely long overcharge. The voltage returns to normal after a discharge-charge cycle.

GETTING MAXIMUM VOLTAGE TO THE MOTOR

The paragraphs that follow are really for the benefit of serious racers only, since they deal with factors that influence the voltage and available power of a Ni-Cd pack. We're talking about a difference of maybe 15% at the most, so if you're just out having fun, don't worry about it.

The output voltage of a fully charged pack can vary considerably depending on the temperature and recent activity of the pack. These effects are listed below.

HIGH TEMPERATURE has its bad effects by lowering the output voltage under load. Less voltage means less speed. At normal 130 deg. F the voltage of six cell pack can be almost a volt less than normal. Since a lot of heat is produced in the pack while the car is running its important to allow air to circulate around the batteries to keep them cool. Before the start of a race keep your car out of the sun and off the hot asphalt.

MEMORY can also affect the output voltage. One such effect is caused by overcharge. The cells "remember" that they were overcharged and put out less voltage near the end of the discharge cycle. This is particularly noticeable if the pack is slow-charged for too long a time.

The second memory effect is caused by repeatedly not using up all of the battery's stored charge before recharging. The cells "remember" that they aren't fully used and let the voltage drop off to about one volt at the point where discharge usually stops. An example would be where you run a series of five minute heats, recharging between each heat, and then try to run an eight minute heat. The battery voltage will be low for the last three minutes of the race. The cure is to fully discharge the pack before recharging. "Full discharge" means the point where the first cell goes dead. Never discharge beyond that point.

The third memory effect is the "topping-up" effect of recent charging. The cells remember that they were recently charged and will produce a little more voltage early in the discharge cycle. Racers take advantage of this by putting the last minute or two of charge into their pack just before the race starts.

GETTING MAXIMUM PERFORMANCE

Full Discharge — Ni-Cd packs perform best if they are **completely** discharged before they are charged. If you are involved in racing you will have to do this if you expect to win any races! Associated Chargers have a discharge

function and various clip-on discharge resistors (about 30 ohms, 10 watts) are available at hobby stores. Discharge for at least an hour (preferably overnight with a clip-on resistor) before charging.

Topping-up — can give you a little extra voltage at the beginning of a race, as long as you don't overdo it. Put the last minute or two of charge into your pack just before the race starts.

RADIO

After the car batteries are charged and the transmitter batteries are charged we'll set the steering servo.

First, slip the Kimbrough servo saver off the steering servo.

Turn the transmitter on.

Plug the battery pack into the wiring harness.

Turn the receiver switch on.

Push the Kimbrough servo saver back on and align so that the wheels are going perfectly straight forward. Install the servo saver screw.

Turn the steering wheel to the right. The wheels should turn to the right. If they turn to the left, move the steering servo reversing switch on the transmitter.

Hold the rear tires off the ground and plug the motor plug into the wiring harness plug. The motor may start to run, which means your speed control must be set. Either way **IT MUST BE SET NOW**. Set it per the manufacturers recommendations. This is a very critical adjustment and will determine the cars top speed and battery life. Set it so there are no brakes. The car will have enough steering, so brakes are not used.

Turn the receiver switch off.

Unplug the batteries.

Turn the transmitter off.

ADJUSTING THE DIFF

From the rear of the car, hold the LH tire in your left hand and the RH tire in your right hand. Now take your right hand thumb and try to rotate the plastic diff gear forward. If you cannot push it forward with your thumb, then loosen the diff adjusting nut #3438 - photo 39, until you can push the gear forward.

Then, going 1/8 of a turn at a time, tighten the nut, check the gear, tighten the nut, check the gear, until you can no longer push the gear forward with your thumb. The diff is now adjusted correctly.

Turn the LH wheel forward and the RH wheel backwards at the same time and you'll be able to

feel how smooth the diff is. You will always want it this smooth whenever you start a race.

If it feels gritty after you've run it, you'll have to take the diff apart, clean the balls and washers, re-lube the balls and put it back together. **NEVER** use the #6636 diff lube on any other part unless we specifically advise it. It **IS NOT** a standard grease.

SETTING THE TWEAK

What is tweak? The left front wheel should be pushing down on the ground with the exact same amount of weight as the right front wheel.

Likewise the left rear wheel should be pushing down on the ground with the exact same amount of weight as the right rear wheel.

If this isn't happening, then the car is **TWEAKED** or twisted. This will cause the car to spin out easily under acceleration, and also cause it to have oversteer in one direction and understeer in the other direction.

To check the tweak, take a ruler and measure from the outside of the LH rear tire to the outside of the RH rear tire. This should be almost 6 3/4". Now take exactly half that amount which will be almost 3 3/8" and mark the **EXACT** centerline of the car on the lower bracket #4322 - 4325 - photos 20 and 21. Just scratch a mark on the bracket with an Exacto knife.

Now set the car on a very flat and level table. Take the Exacto knife blade and put the edge of the blade underneath the bracket, **EXACTLY** where your mark is and very slowly lift up on the blade. **BOTH** rear tires should come up off the table at **EXACTLY** the same instant. If one tire lifts off the table the slightest amount before the other tire, the car is tweaked.

To correct the tweak, refer back to photo #16. Loosen one screw 1/8 of a turn and tighten the other one 1/8 of a turn. Recheck the tweak. Keep doing this procedure until the tweak is flat.

REMEMBER - Always loosen one of the screws first and then tighten the second screw the exact same amount.

CASTER - We've found that 2 degree caster is very good, but you can experiment with this on your track.

TOE-IN - Normally use no toe-in or toe-out. If you run on a very slippery track you might want to try some toe-in. This is done by adjusting the #4126 - photo 53 tie rods so they're a little longer.

RIDE HEIGHT ADJUSTER - Photo #25 and 29. If you want the ride height adjuster washers to slip more freely on the upper bracket, photo 27, you can spray the upper and lower surfaces of the bracket, in the washer area, with dry graphite spray in spray cans, available in hardware stores.

If you want more shocking action, coat the bracket with #6636 diff lube photo 34.

T-BARS - The kit comes with 2 T-bars. A thin .062 and a thick .074 one. Normally you'll use the thin one. In rare, extremely high traction situations you'll want to install the thick T-bar. On very slippery tracks, you should even try narrowing the thin T-bar in the same shape as the thick T-bar. this will increase rear traction.

REAR CHASSIS HEIGHT ADJUSTMENT - The rear of the chassis can be raised or lowered by installing different axle bearing holders - photo 41. You can run large rear tires or small rear tires and still maintain enough ground clearance.

TIRES - We've found our green front tires #3669 and our rear green tires #3625 work super on carpet.

Asphalt tracks vary quite a bit and you'll have to do some testing on your own track for optimum performances. On the rear, try our yellow #3624 and our green #3625. On the front try our green #3669 and our new G-S tires #3662. Always glue the rear tires full width, but only glue the front tires as much as you need for steering. The car has a lot of steering, so go easy on the front tire gluing.

TRANSMITTER DUAL RATE - You always want to turn the front wheels the **LEAST AMOUNT NECESSARY** to get around the track fast, not the most amount. So use the dual rate switch on your transmitter to give you the exact amount of steering you need and **NO MORE**.

BODY - Mount your body on the car while it is still clear, so that you can see through it to easily mark the body mount holes and antenna holes.

The best Can Am body to use is our [REDACTED] #3160. It won 3 World Championships. There is none better.

In the coupe class our #3169 [REDACTED] and #3171 [REDACTED] are the best.

There are a lot of good body paints on the market now, and one of the best is the R/C car body paint by Pactra in the spray cans.

WINGS - You will not need a wing if you run on carpet. However, if you run on asphalt you **MUST** run a wing. You'll notice 2 small wing wire mounting holes on top of the rear bulkheads.

GOOD LUCK IN YOUR RACING!!

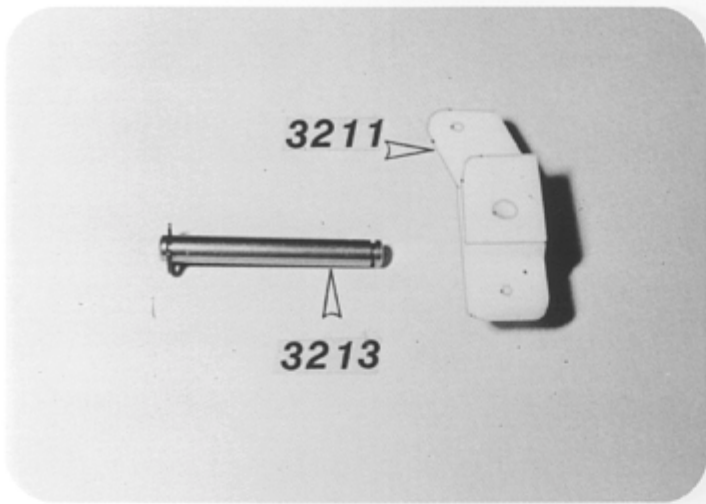

Photo 1

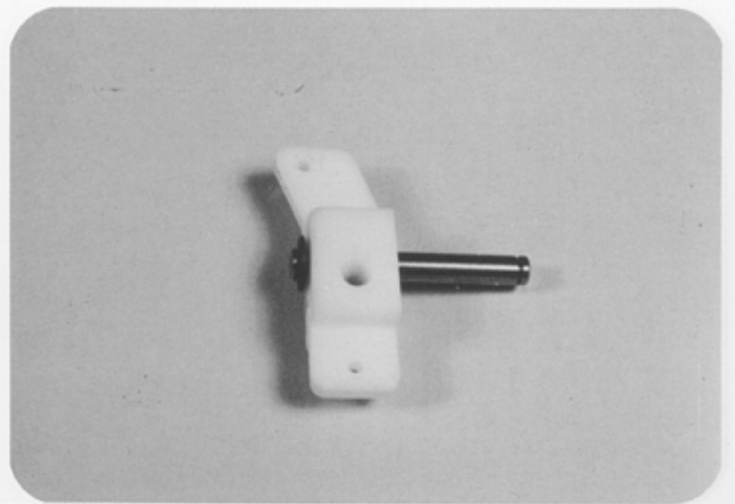
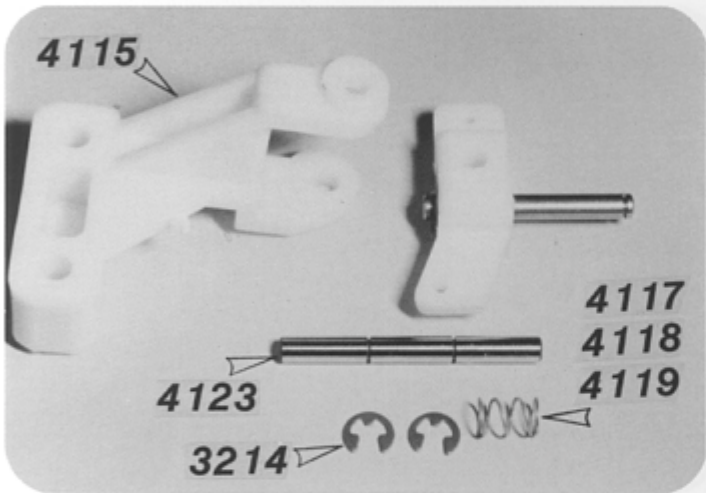
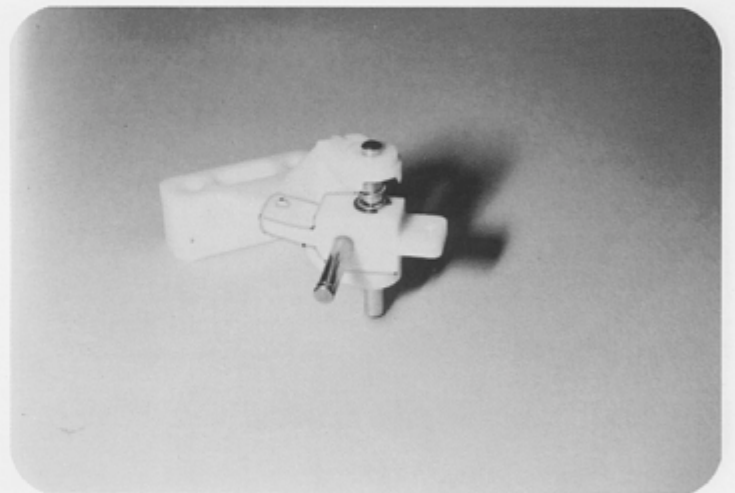

Photo 2



3



4

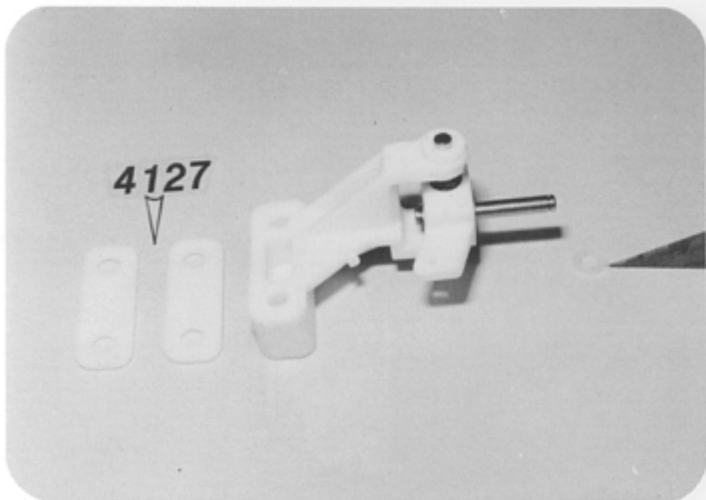

5

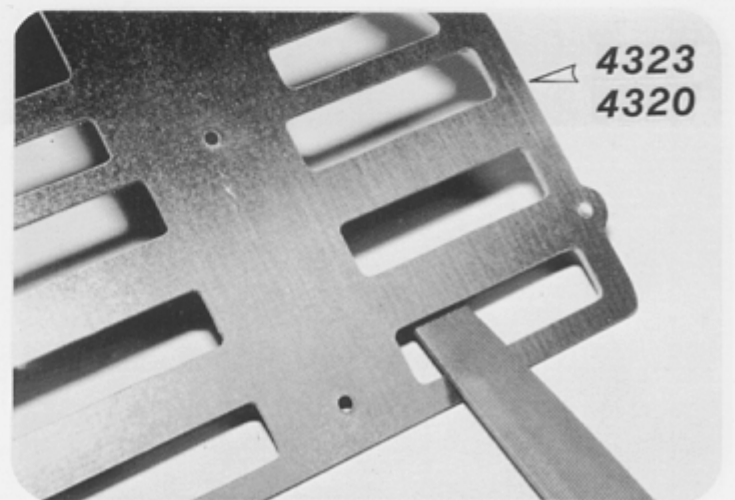

6

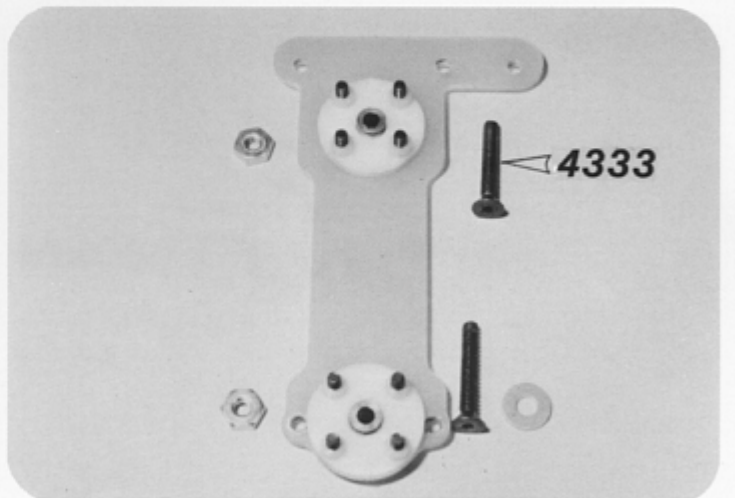
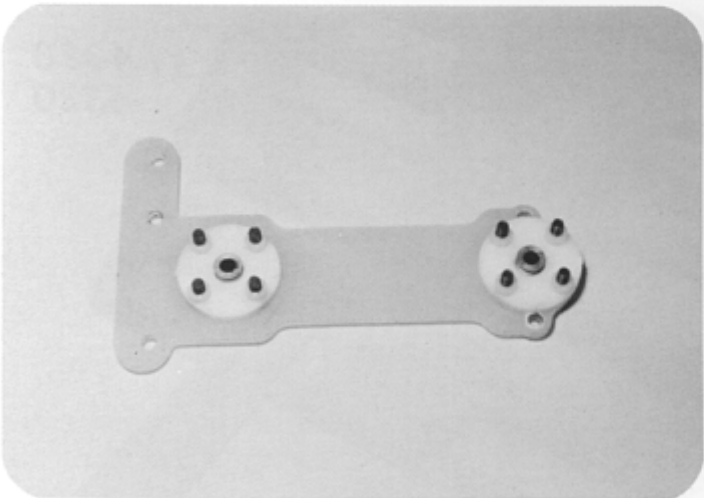
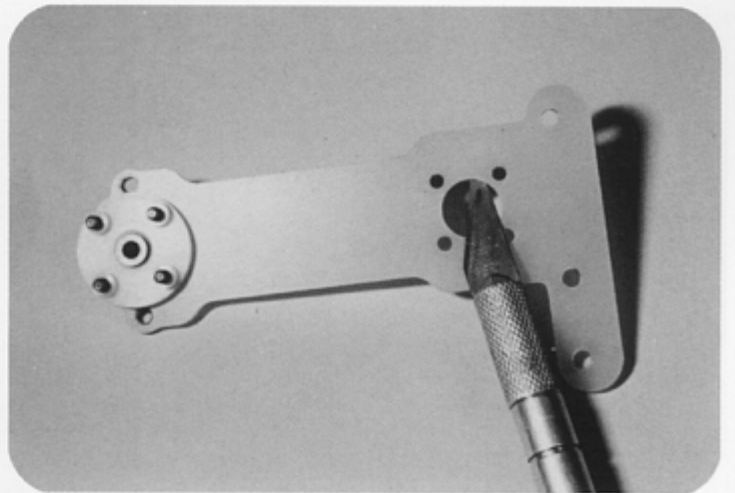
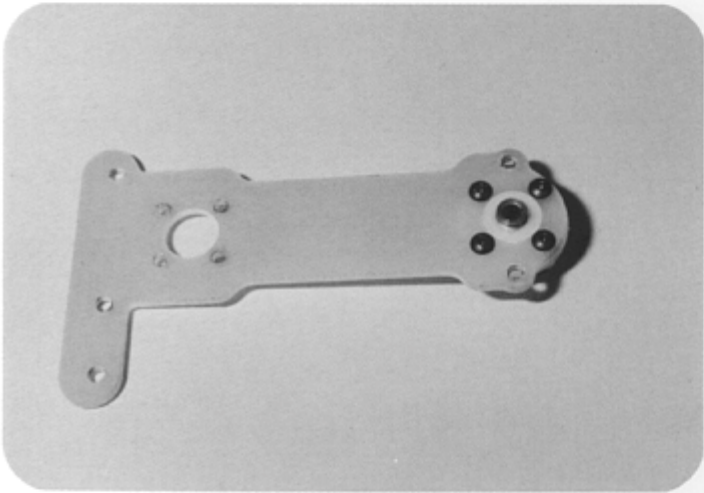
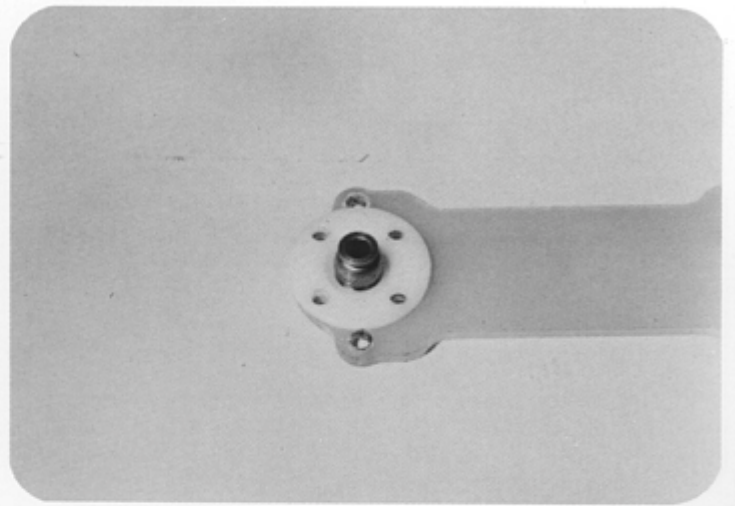
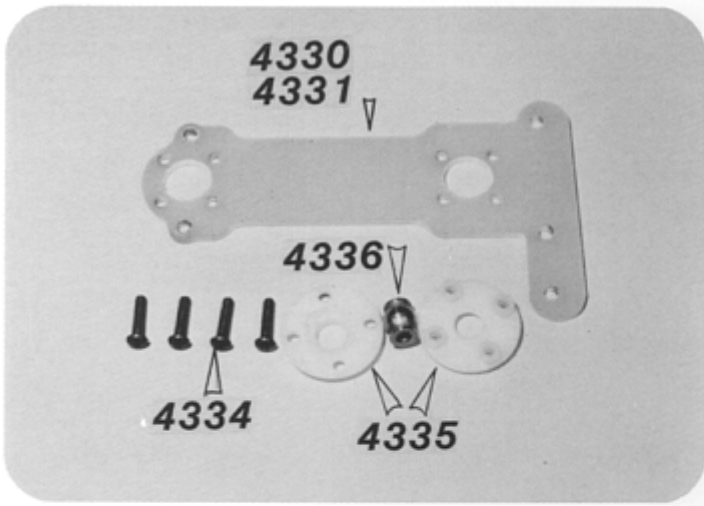

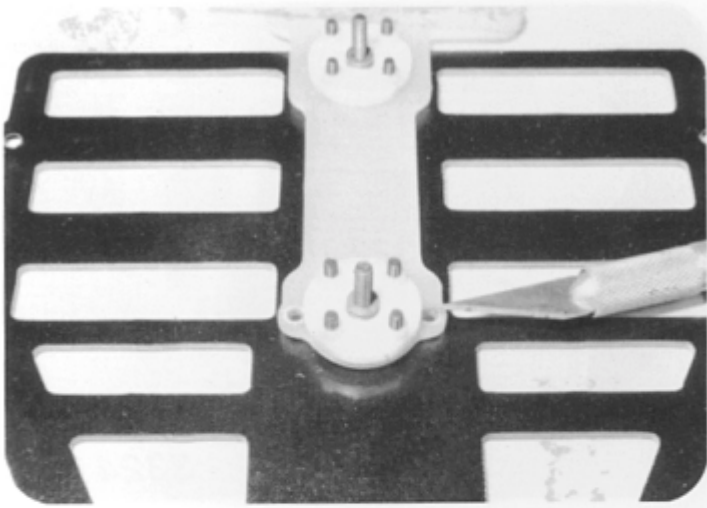

13



14

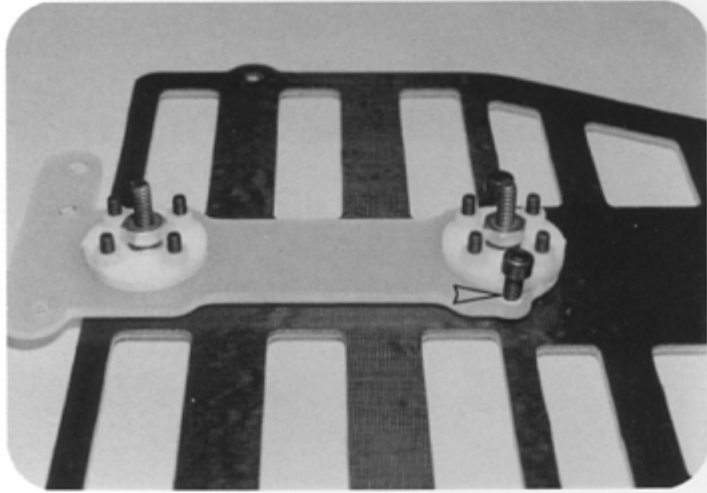

15

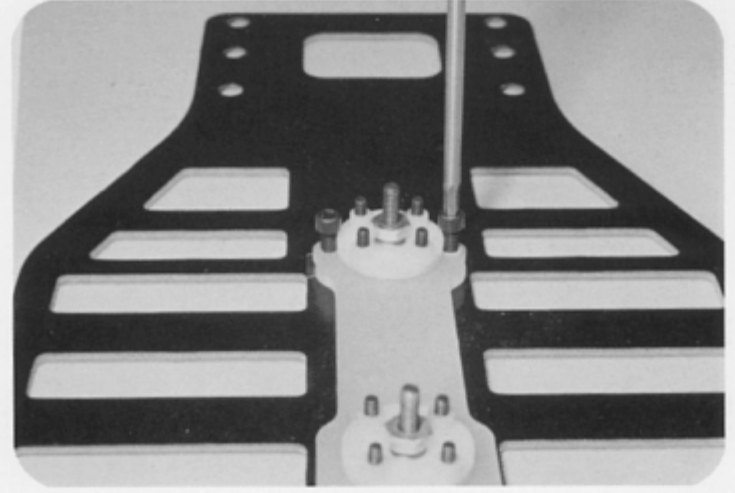

16

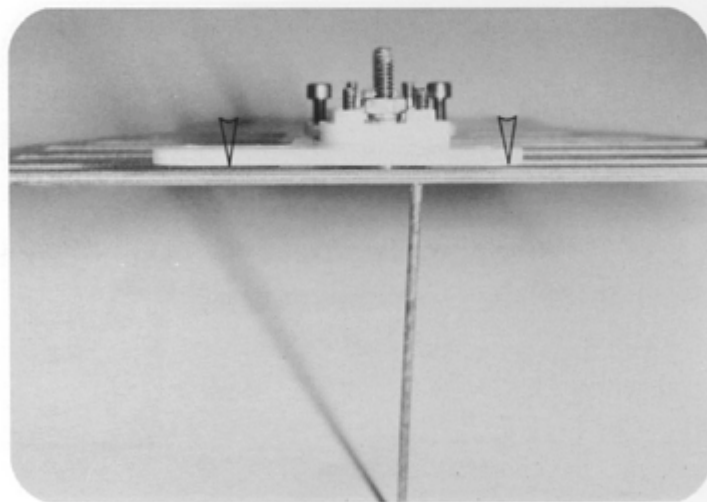

17

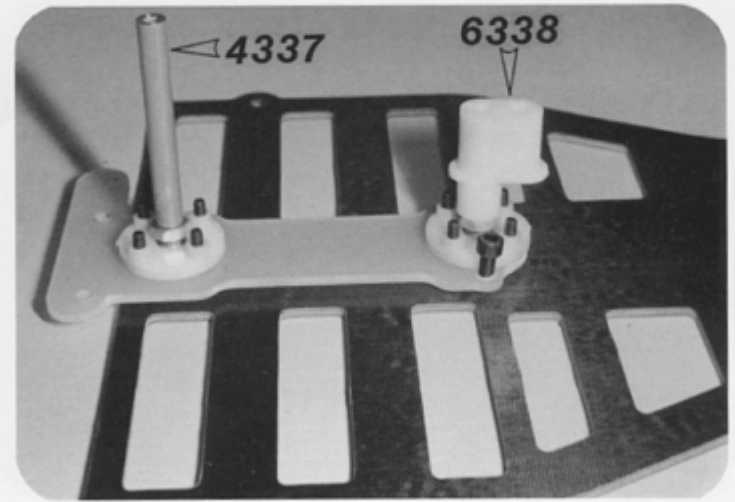

18

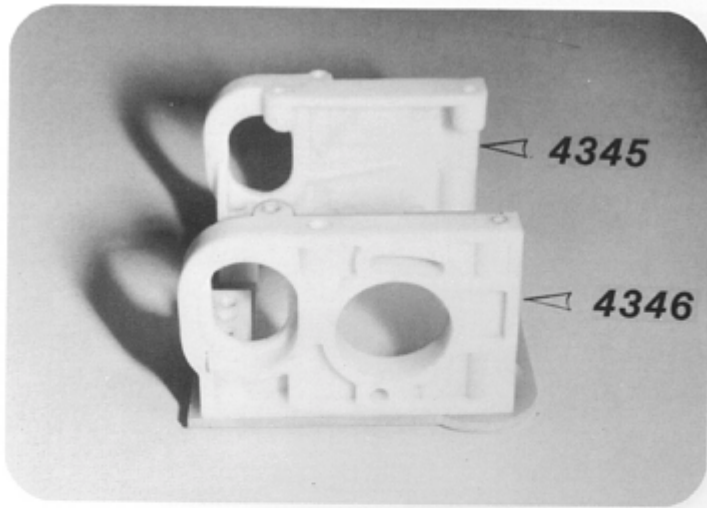

19

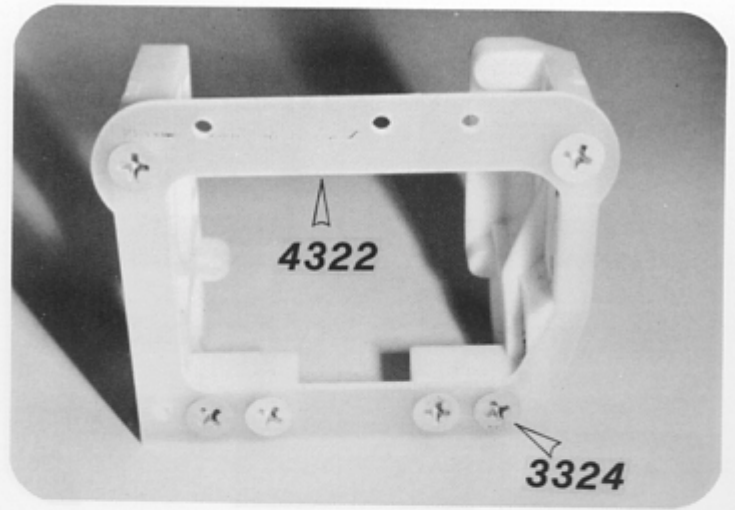

20

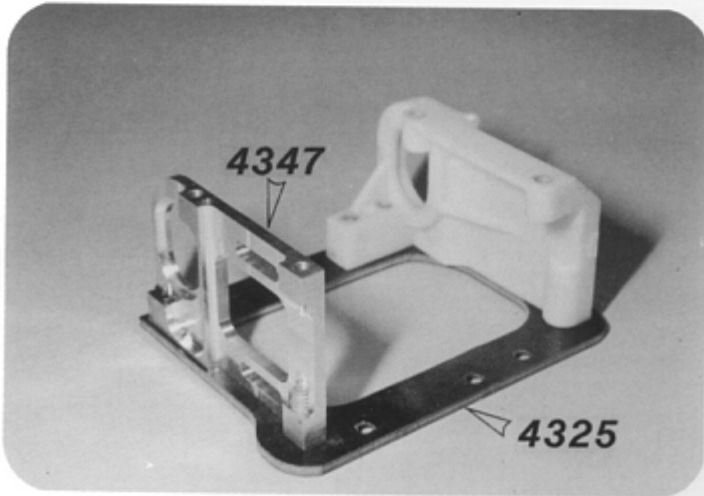

21

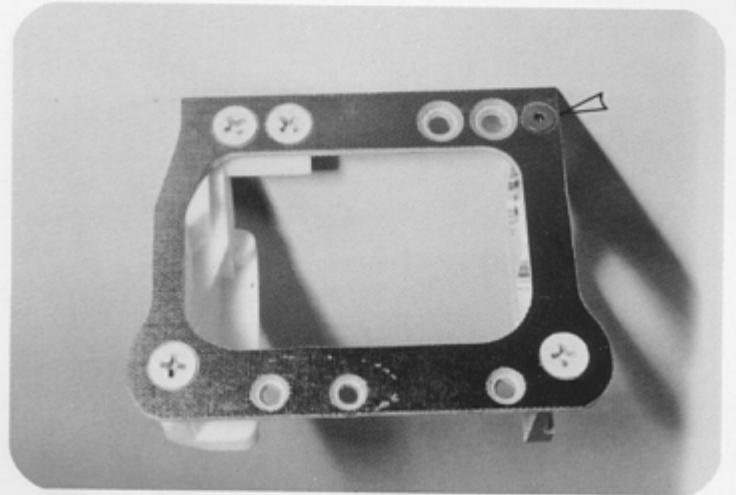

22

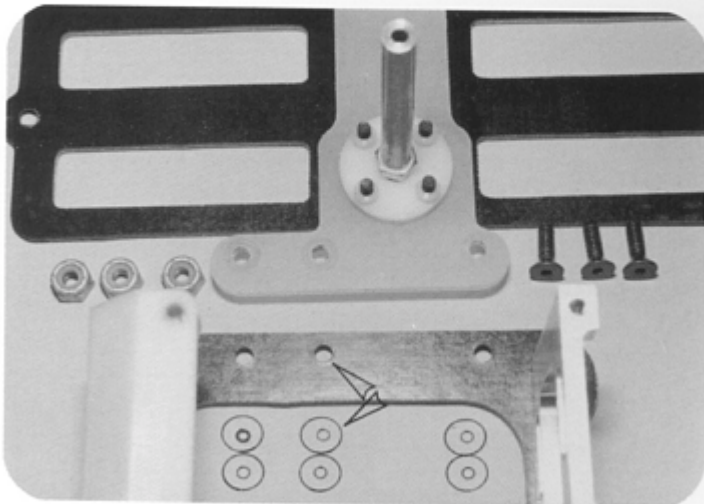

23

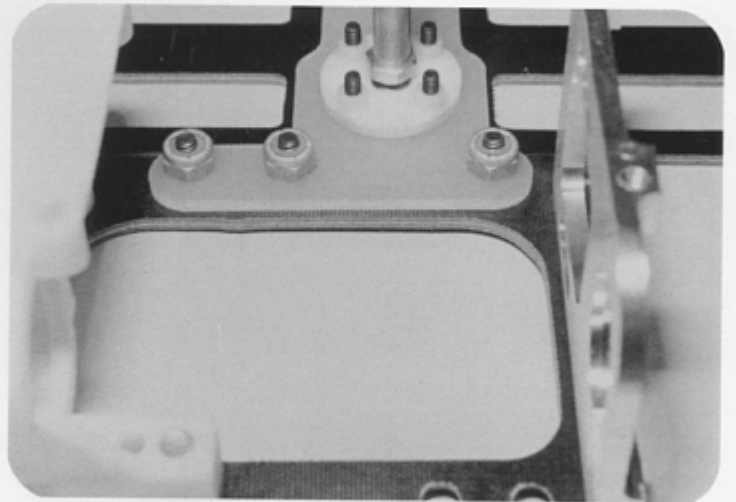

24

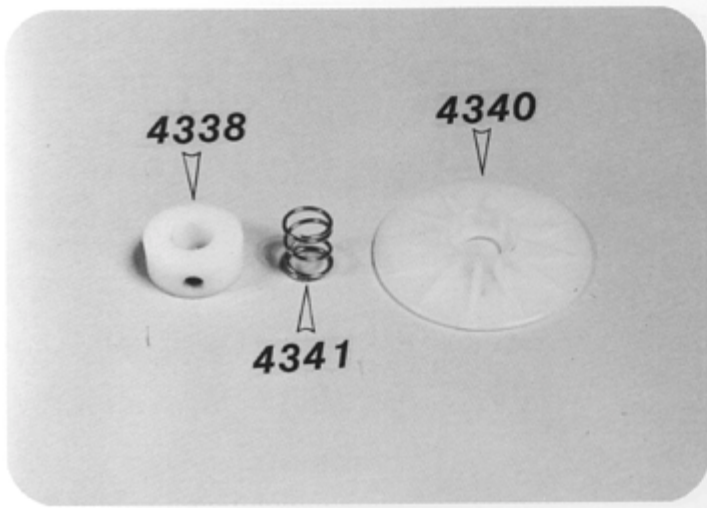

25

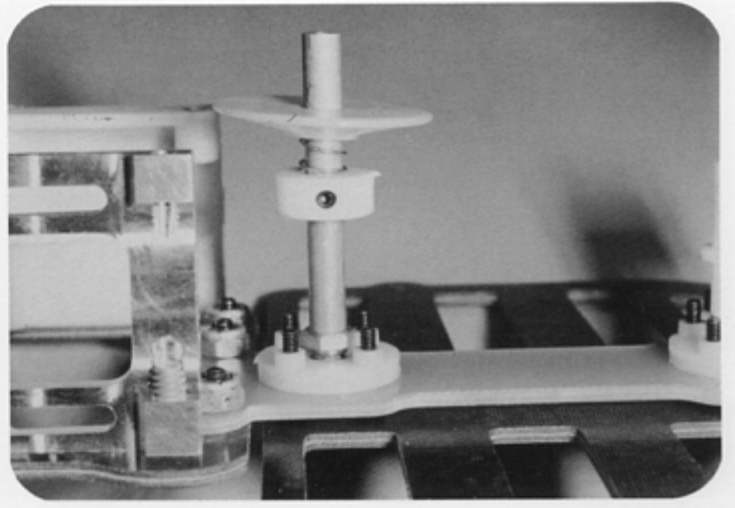

26

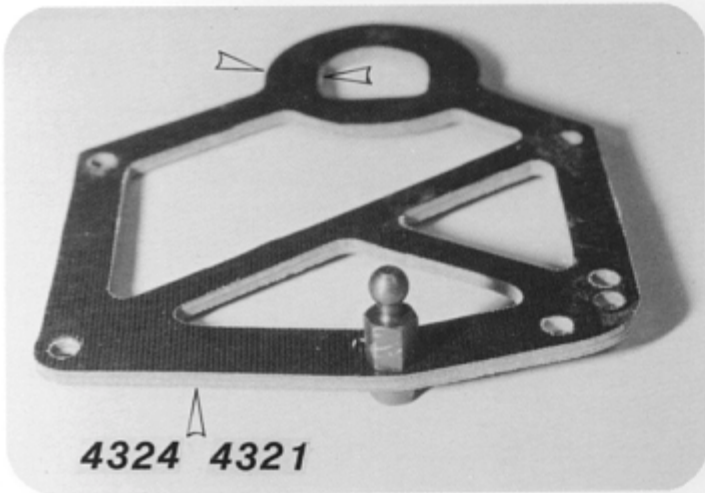

27

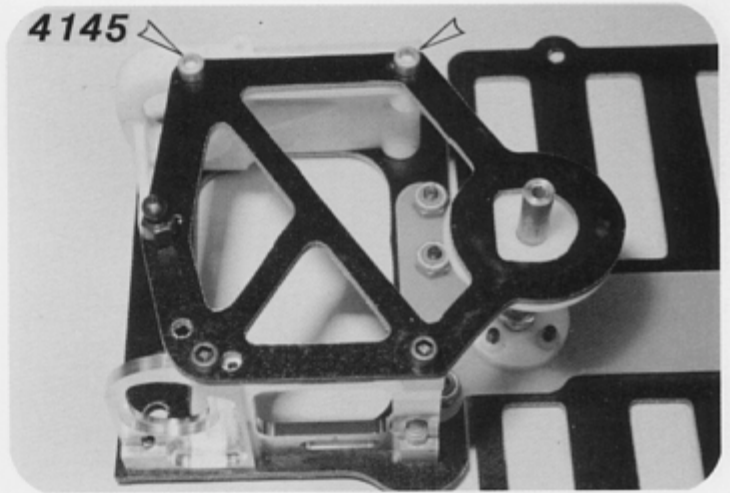

28

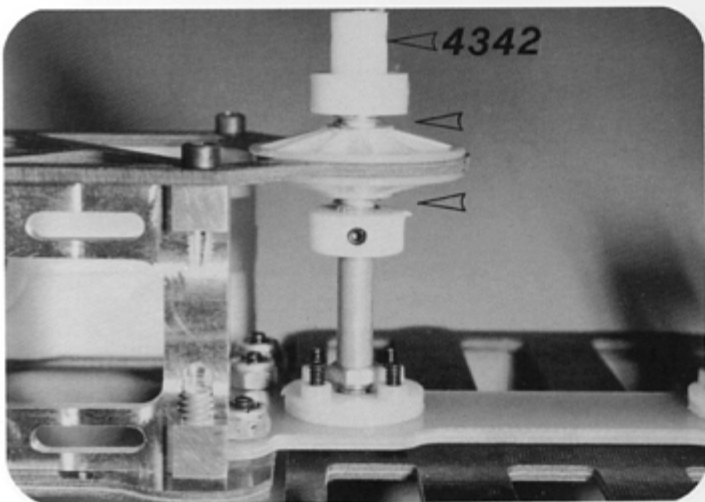

29

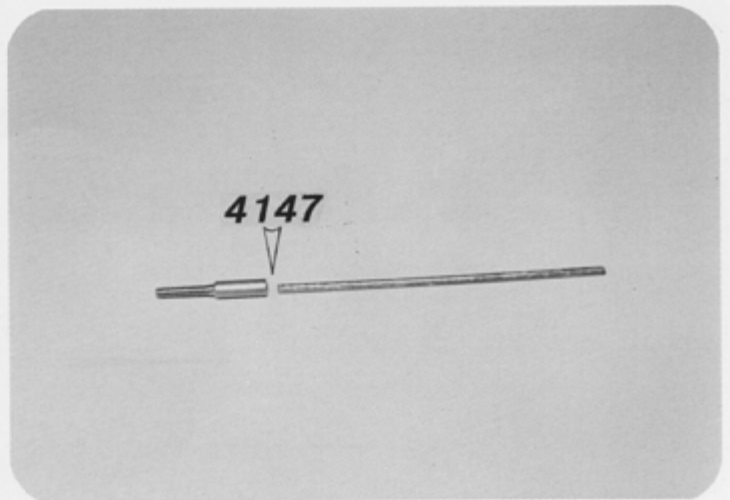

30

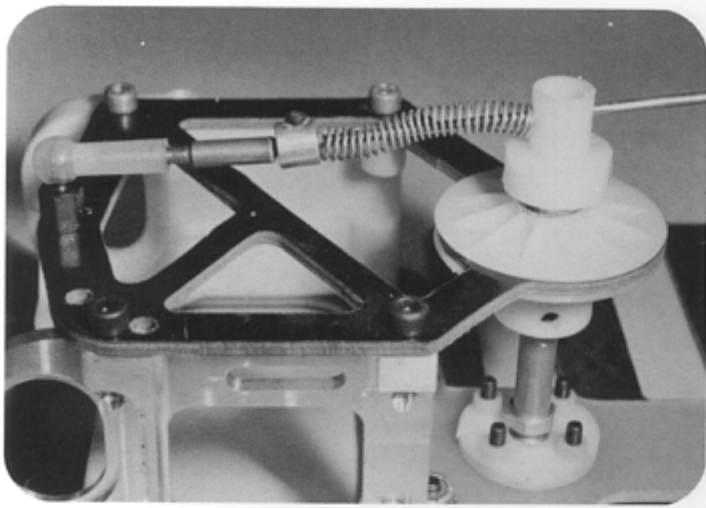

31

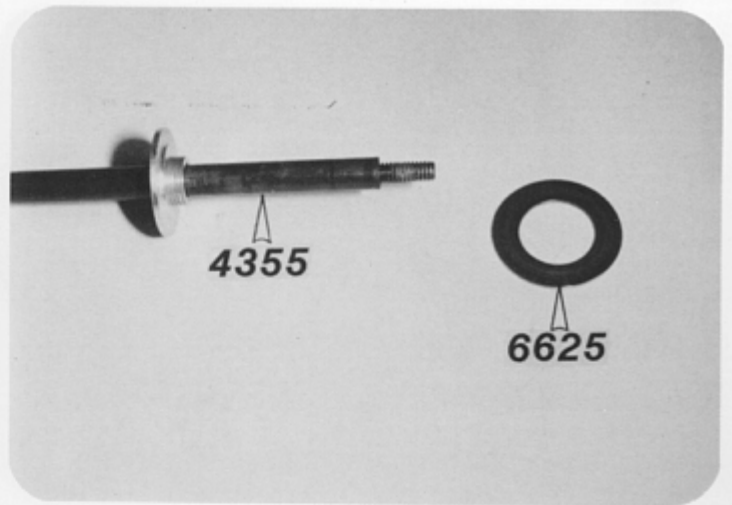

32

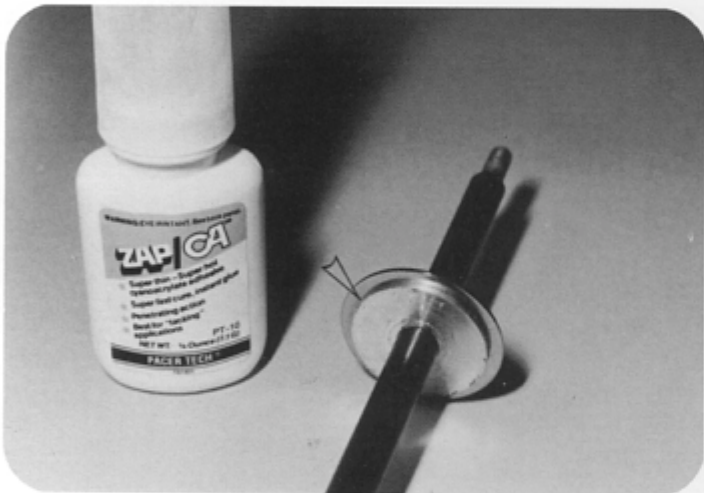

33

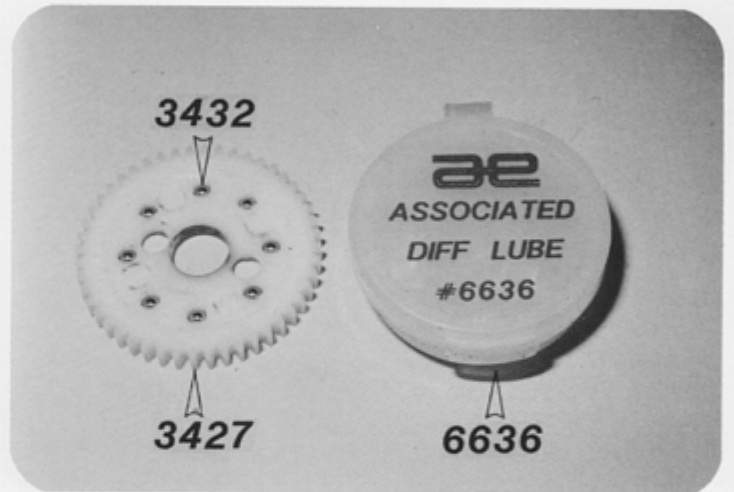

34

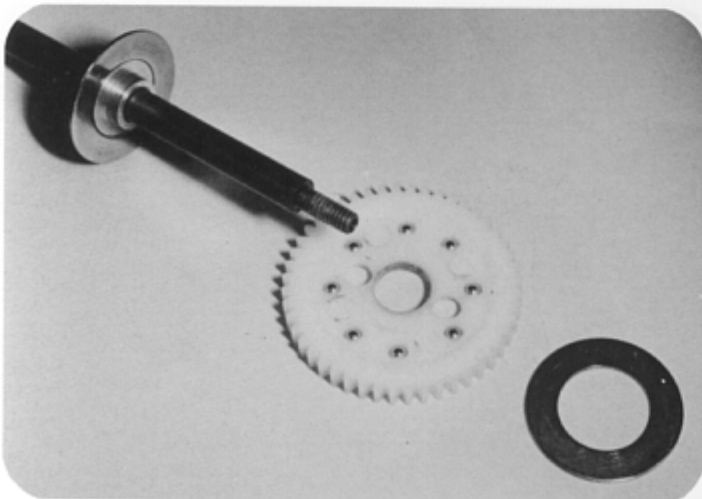

35

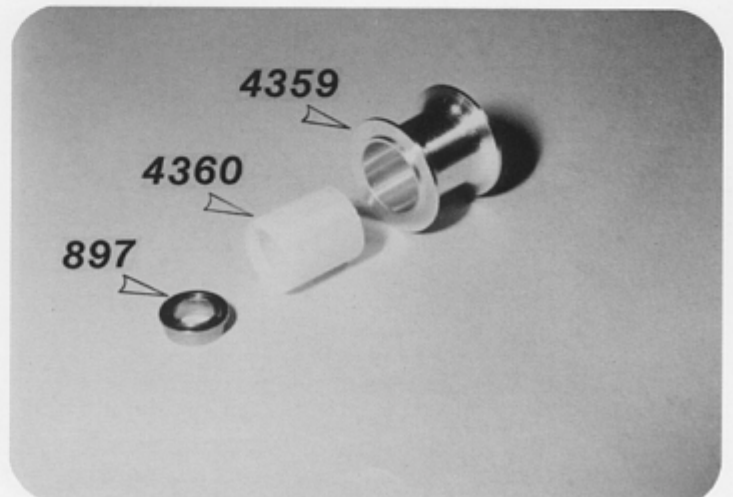

36

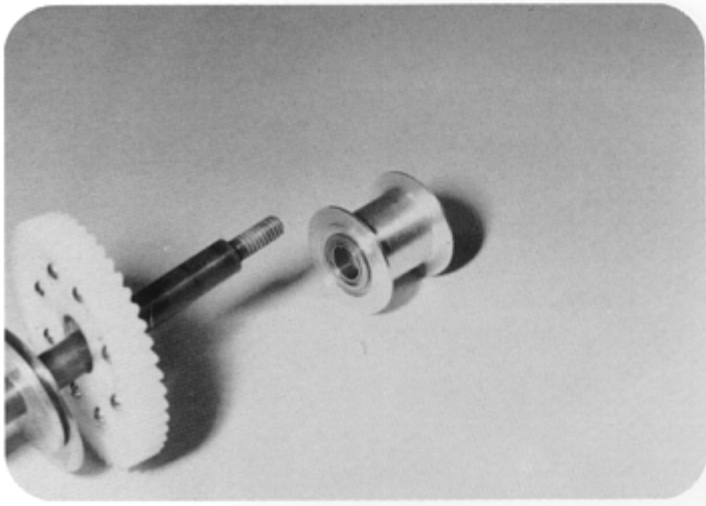

37

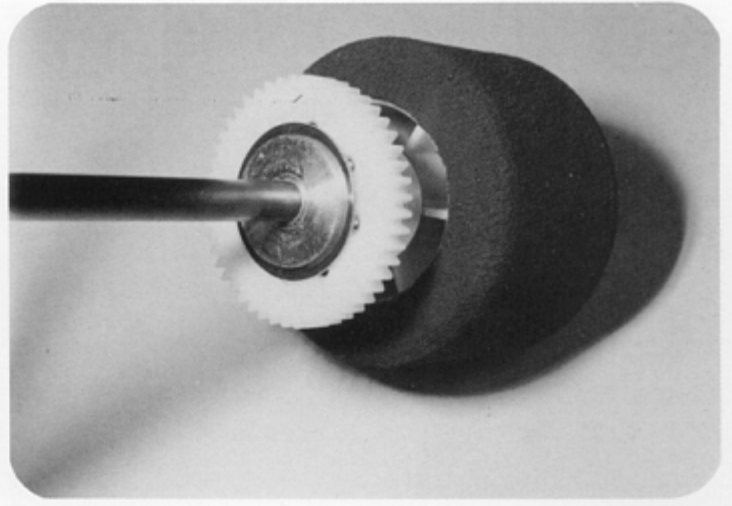

38

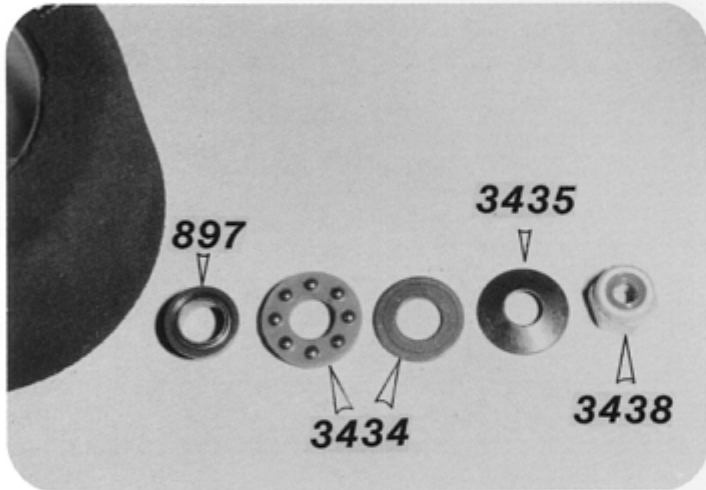

39

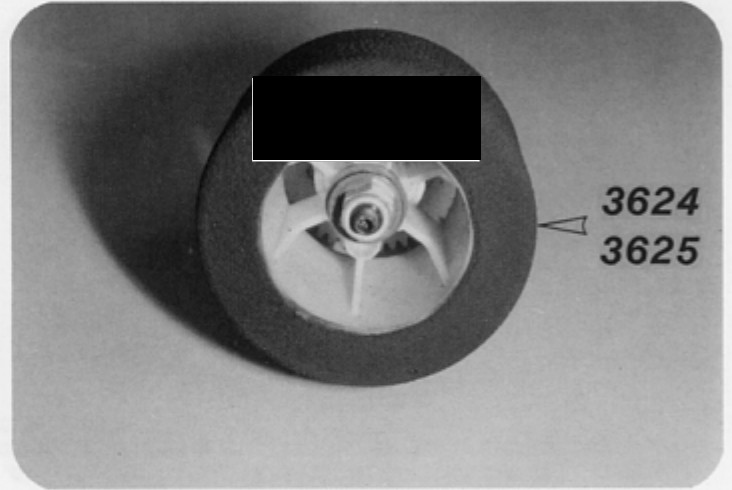

40

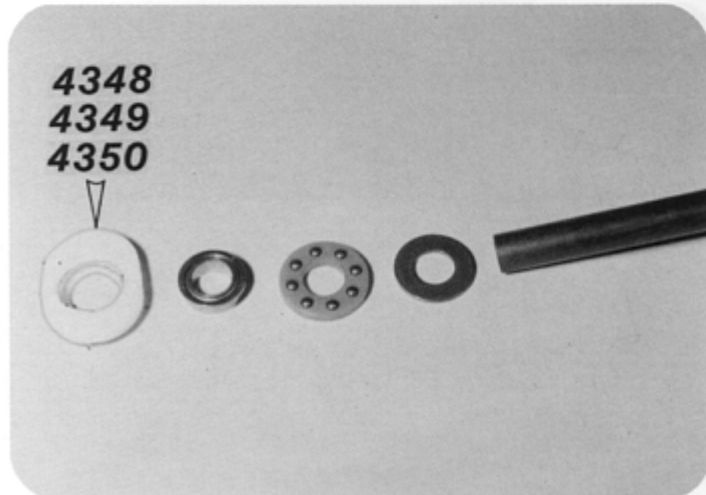

41

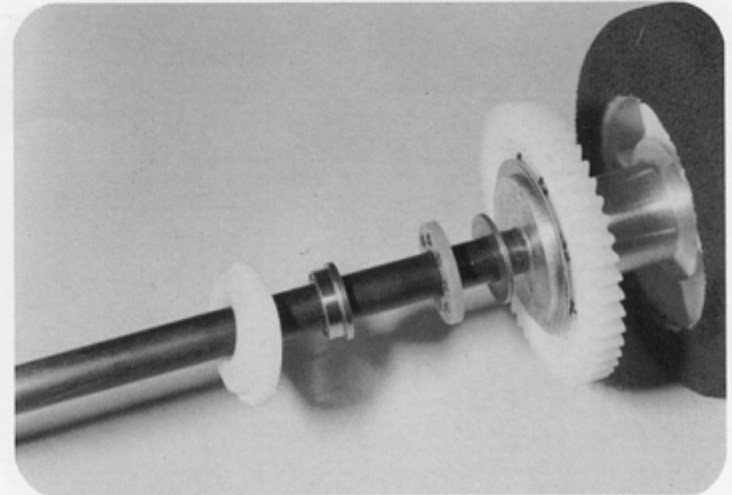

42

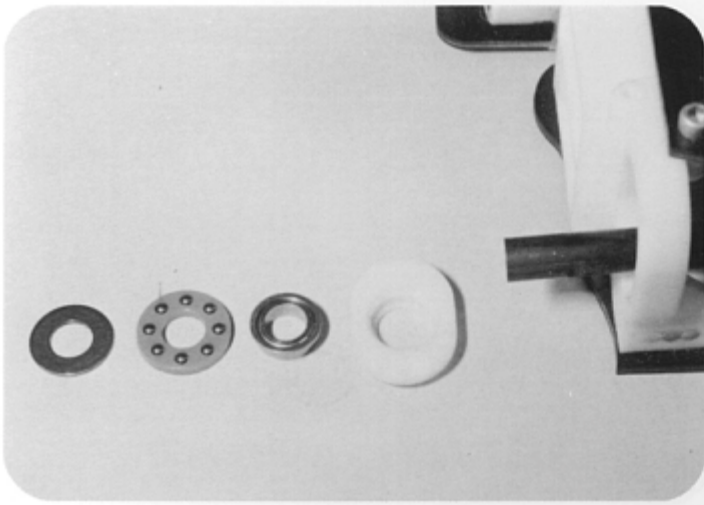

43

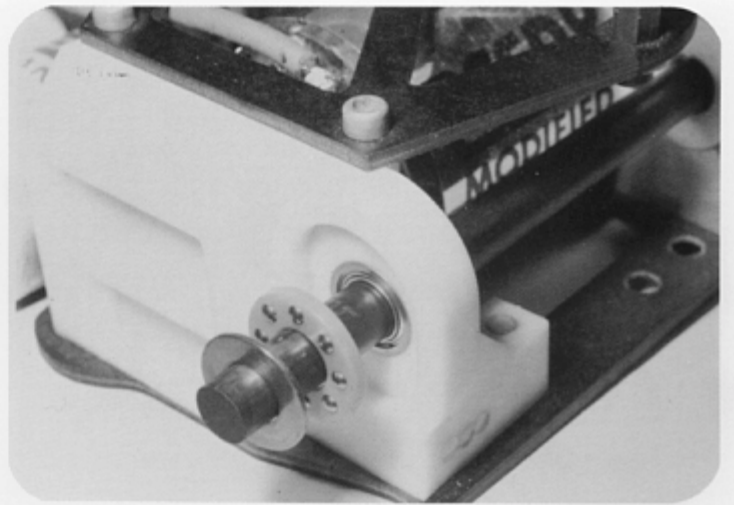

44

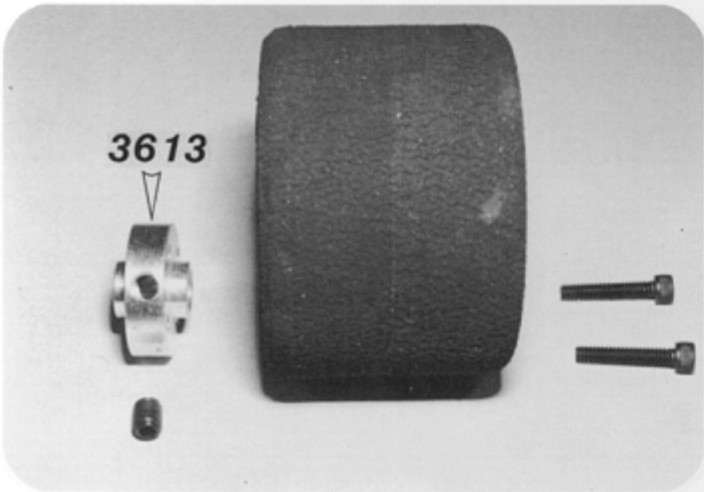

45

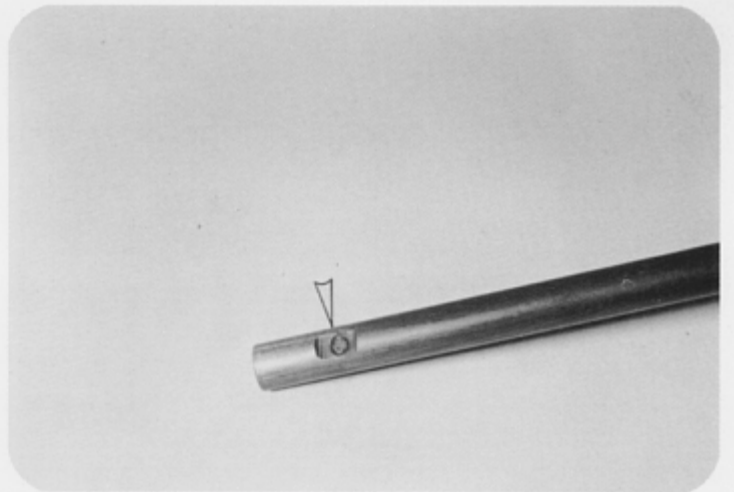

46

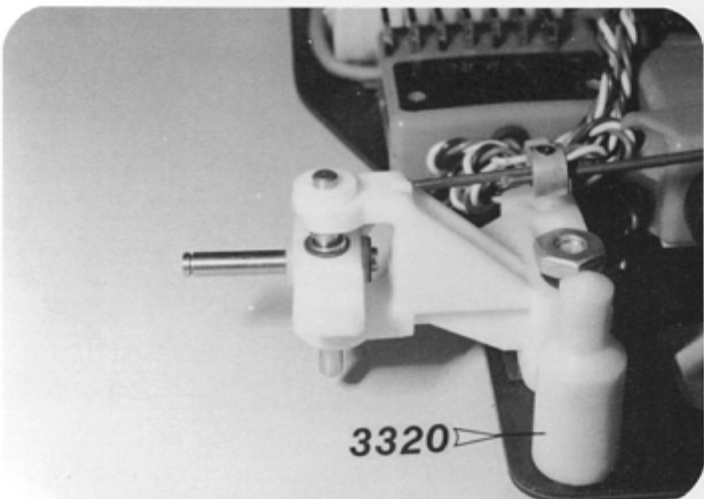

47

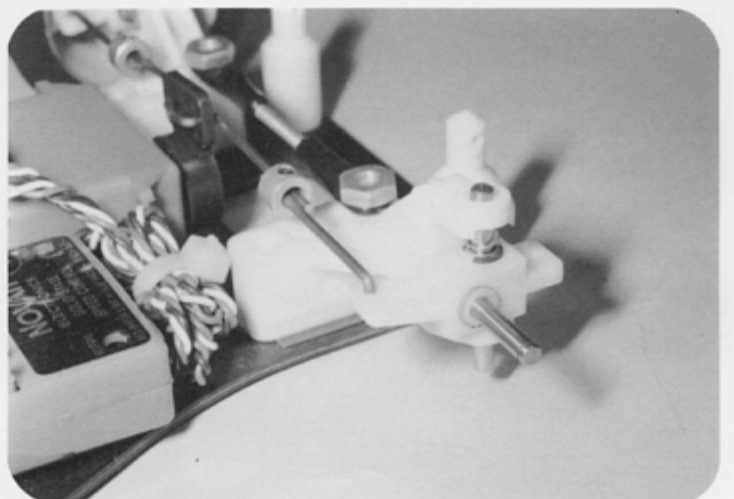

48

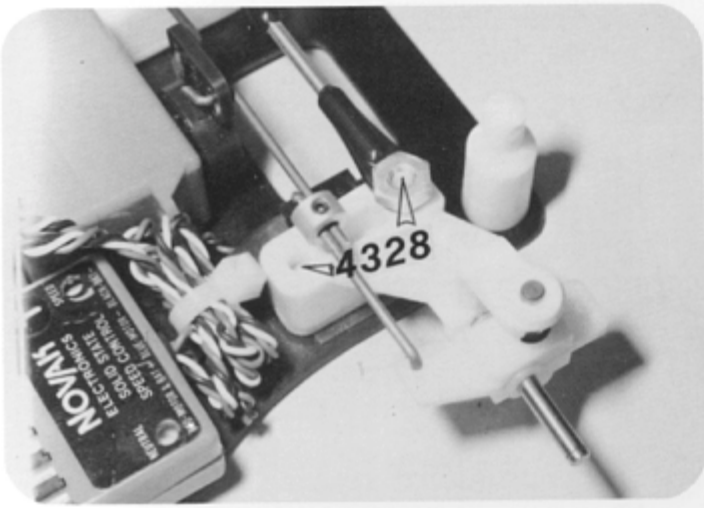

49

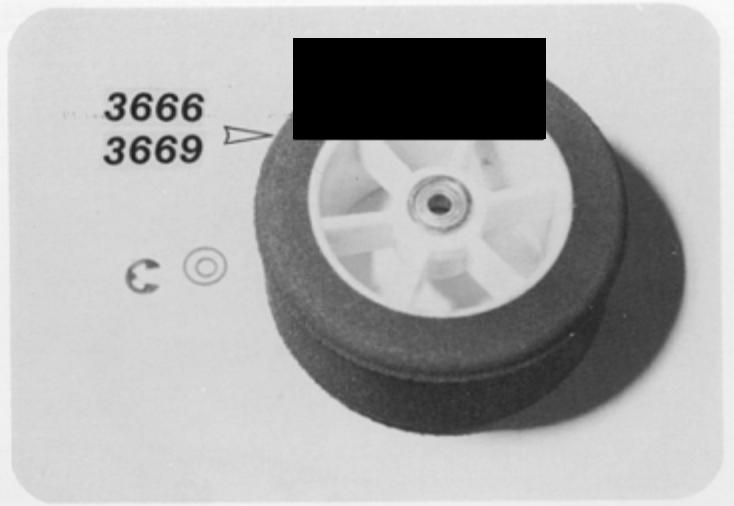

50

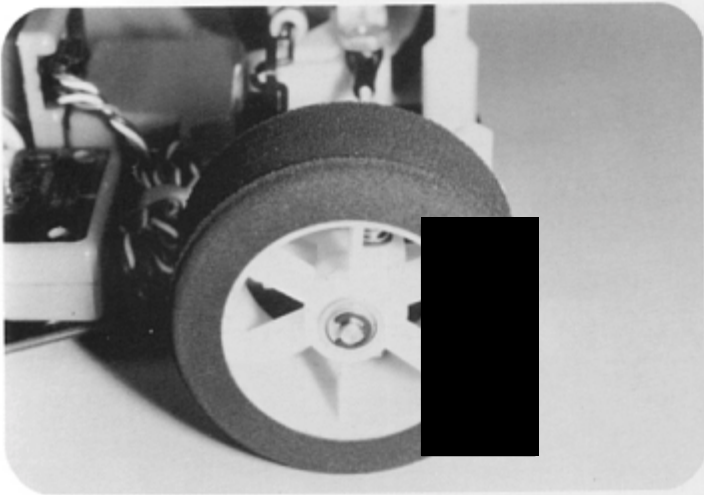

51



52

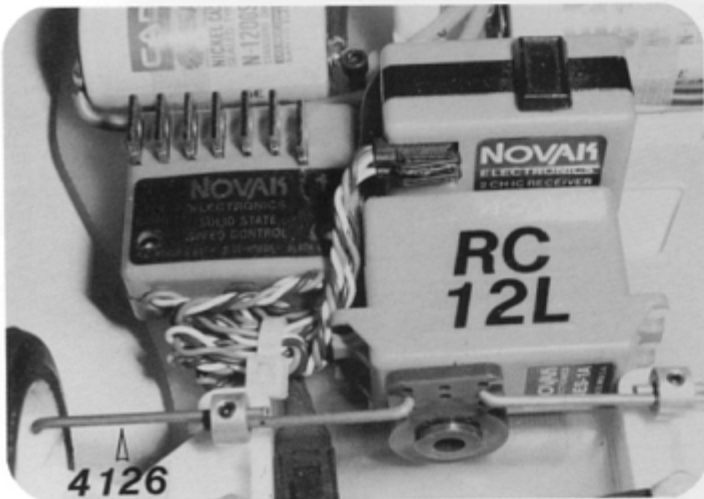

53

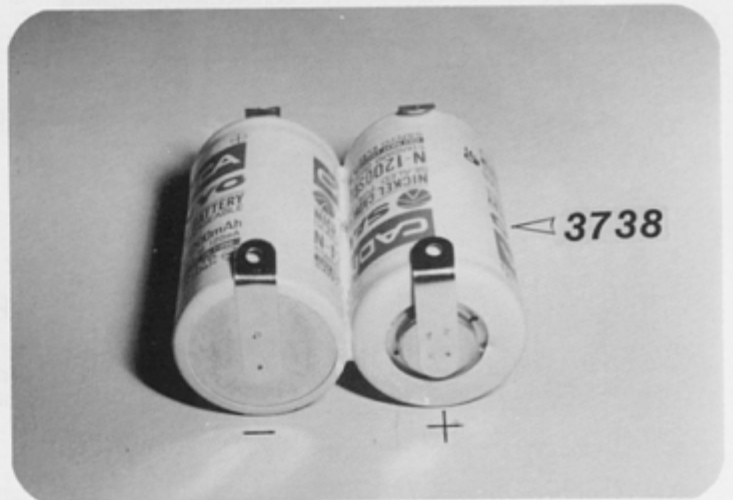

54

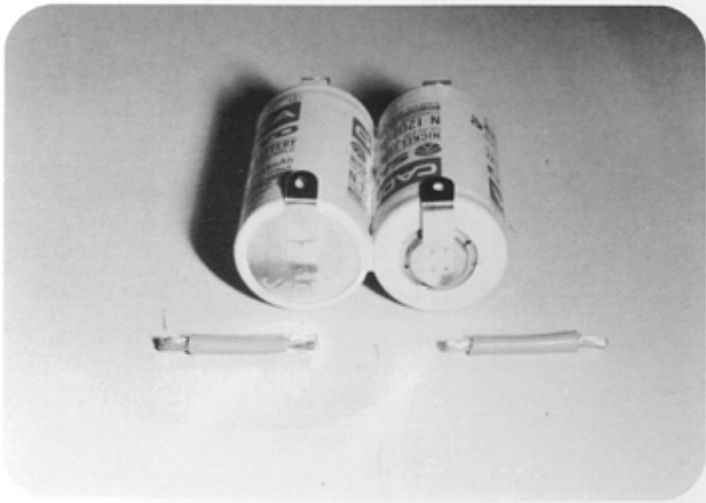

55



56



57

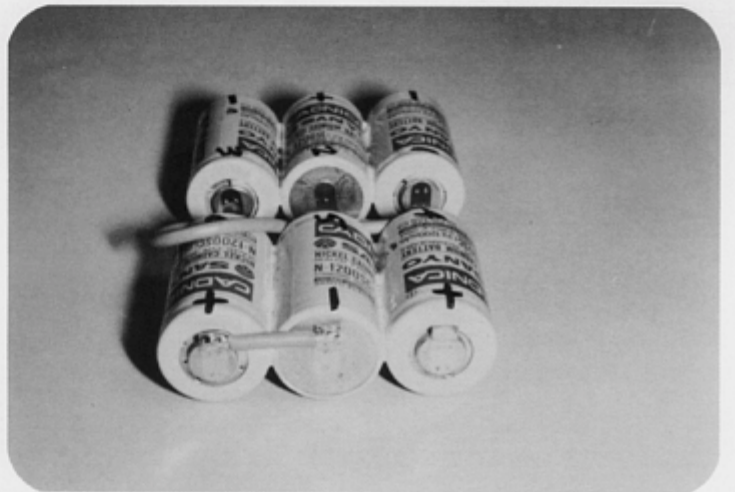

58

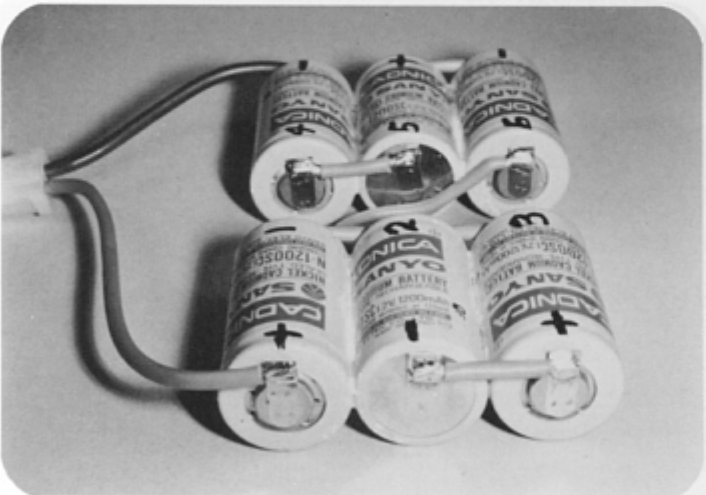

59

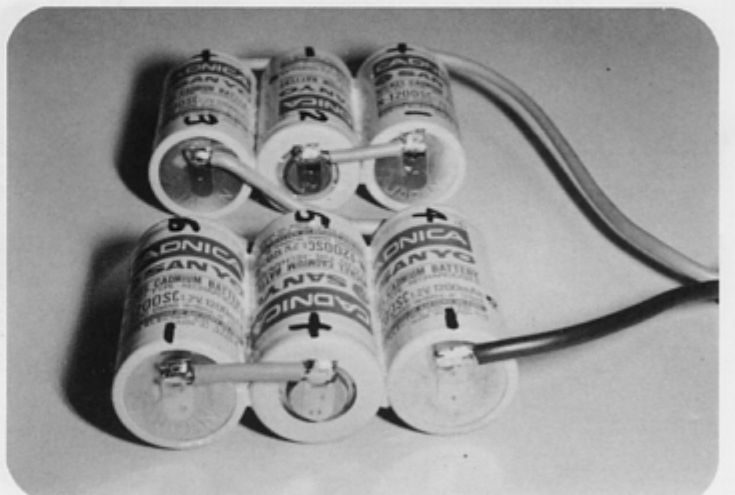

60

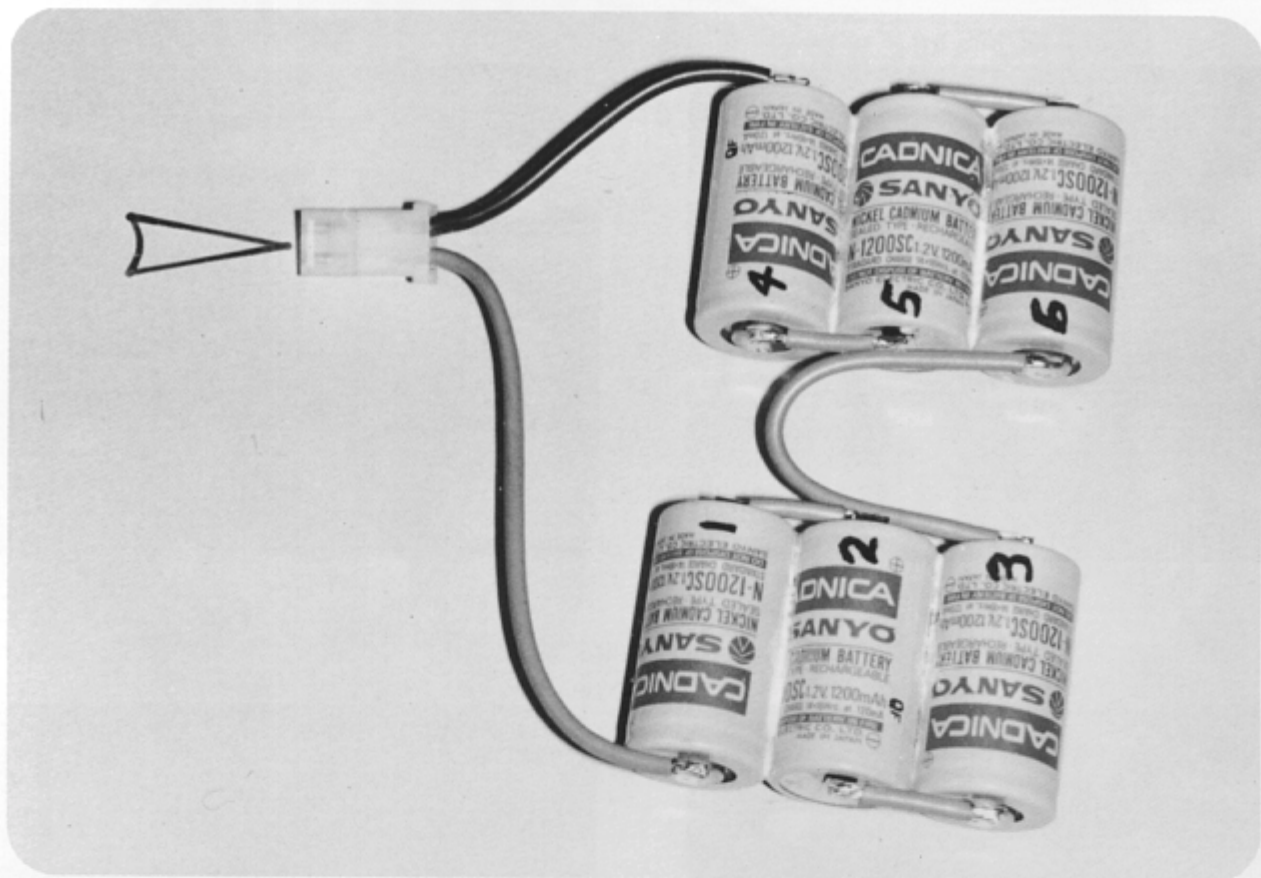

61

62

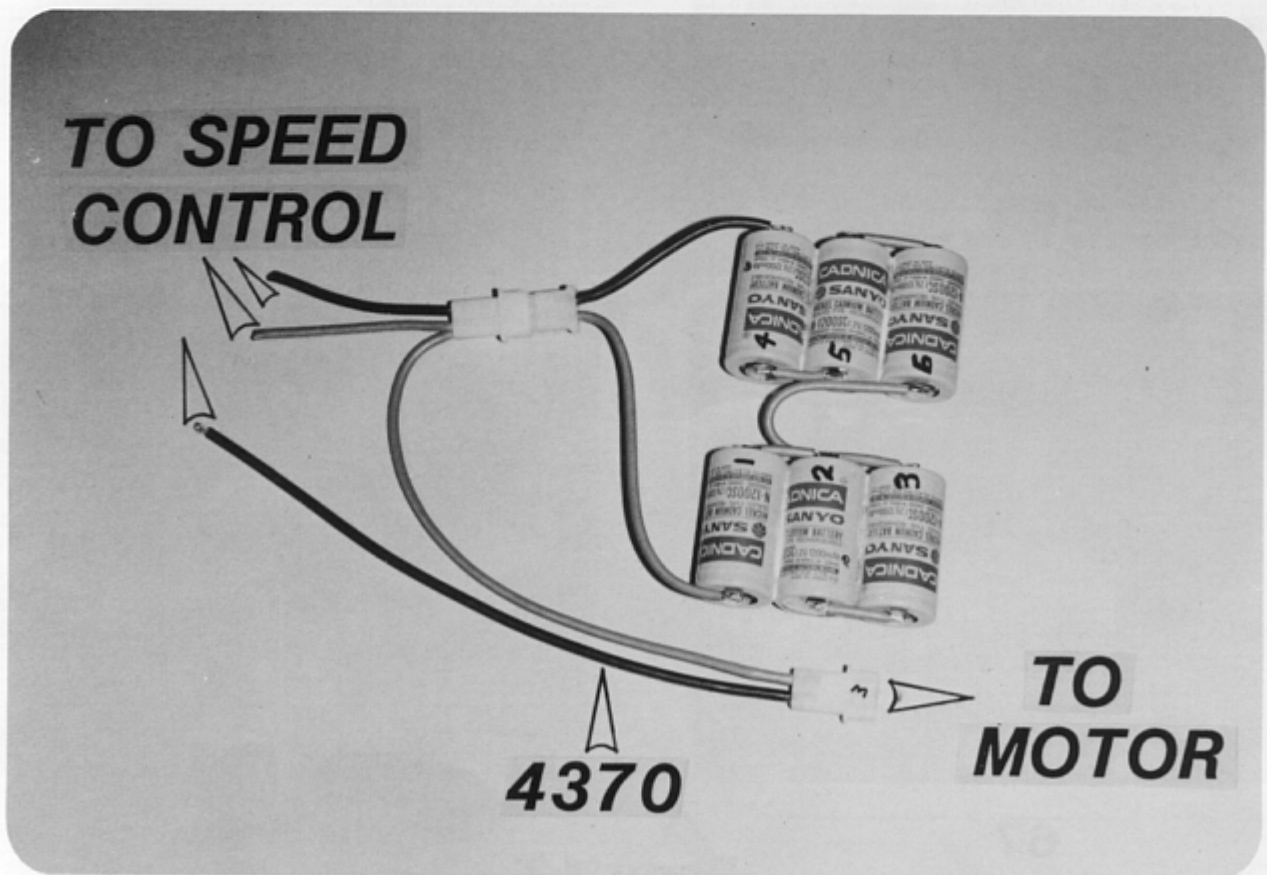

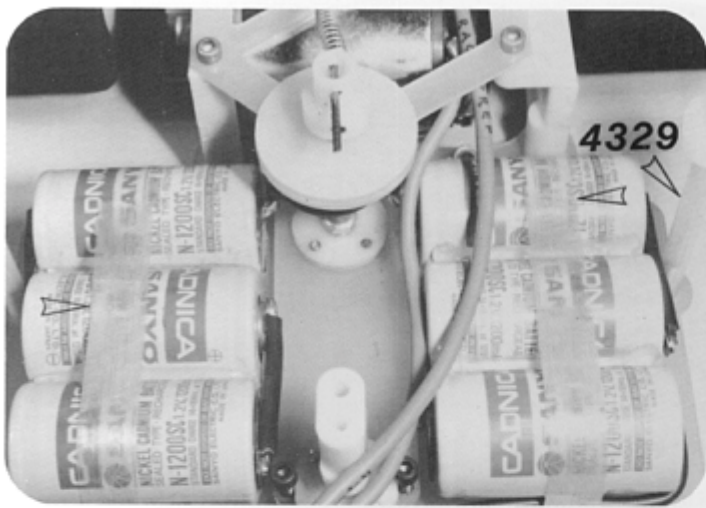

63

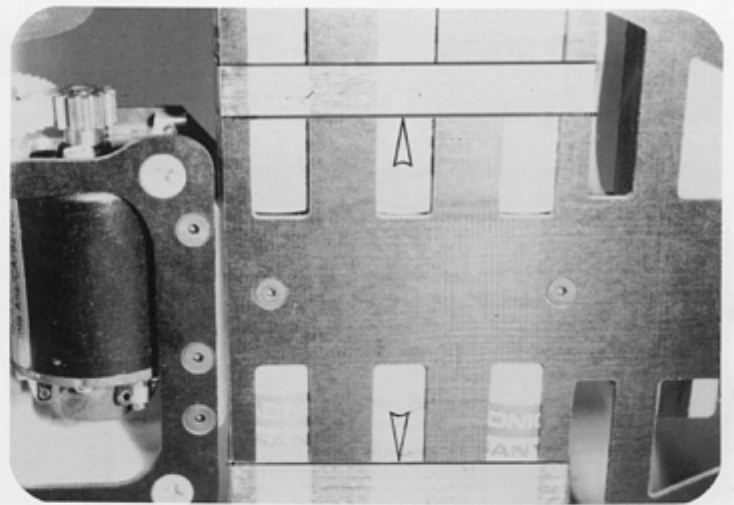

64

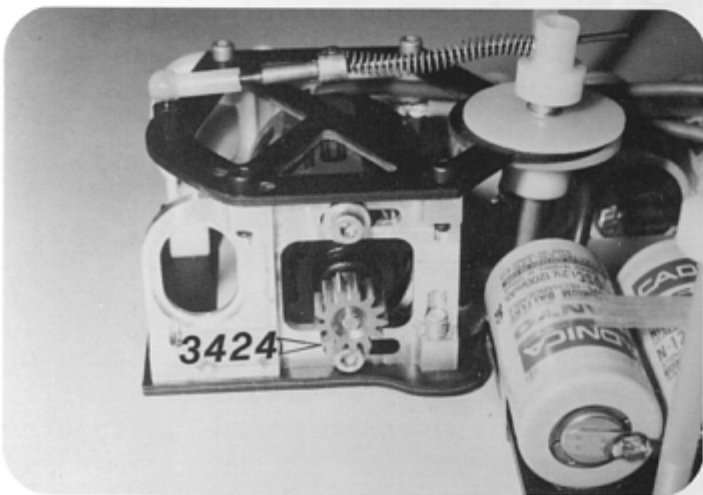

65

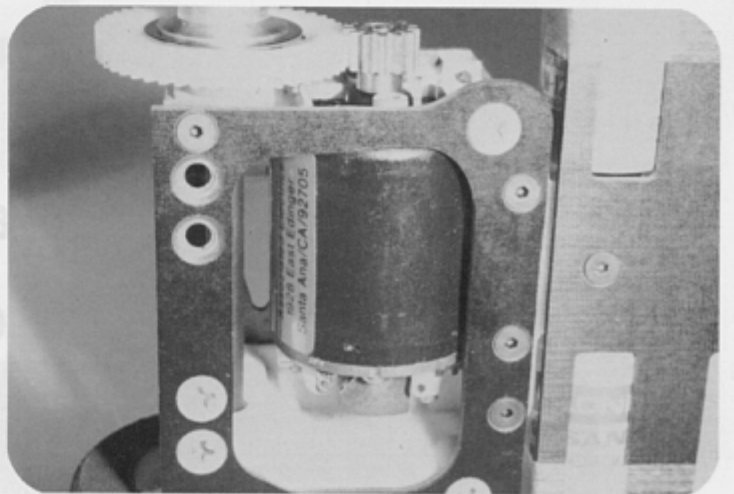

66

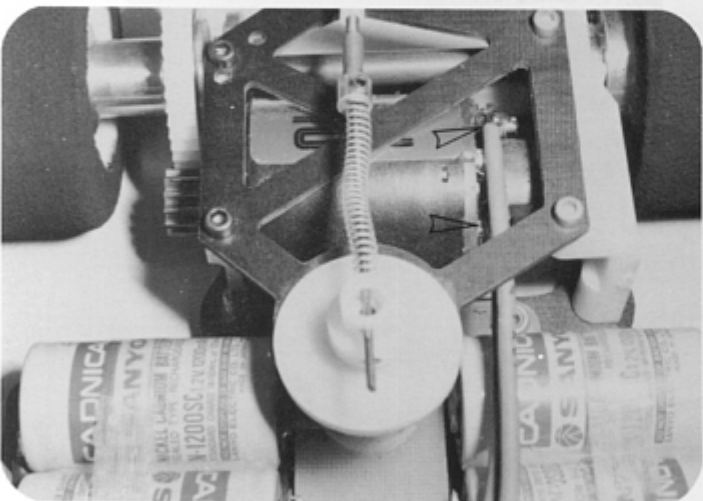

67

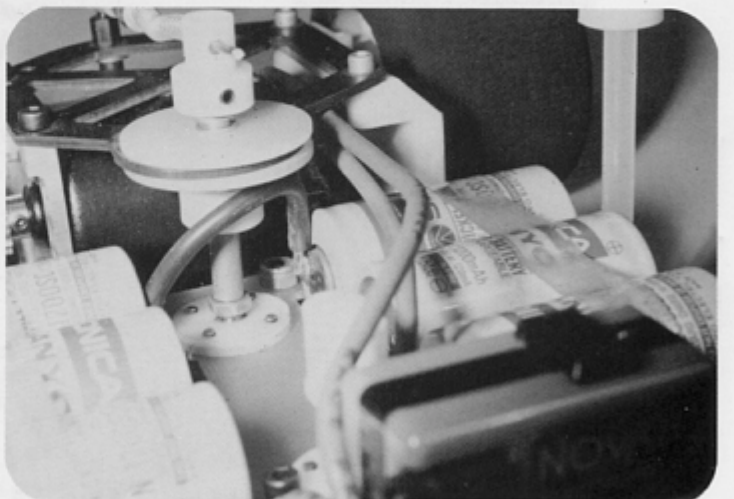

68



ASSOCIATED ELECTRICS INC. 3585 Cadillac Ave., Costa Mesa, CA 92626 • USA

Phone (714) 850-9342

Telex 756887