

RC12LW GRAPHITE

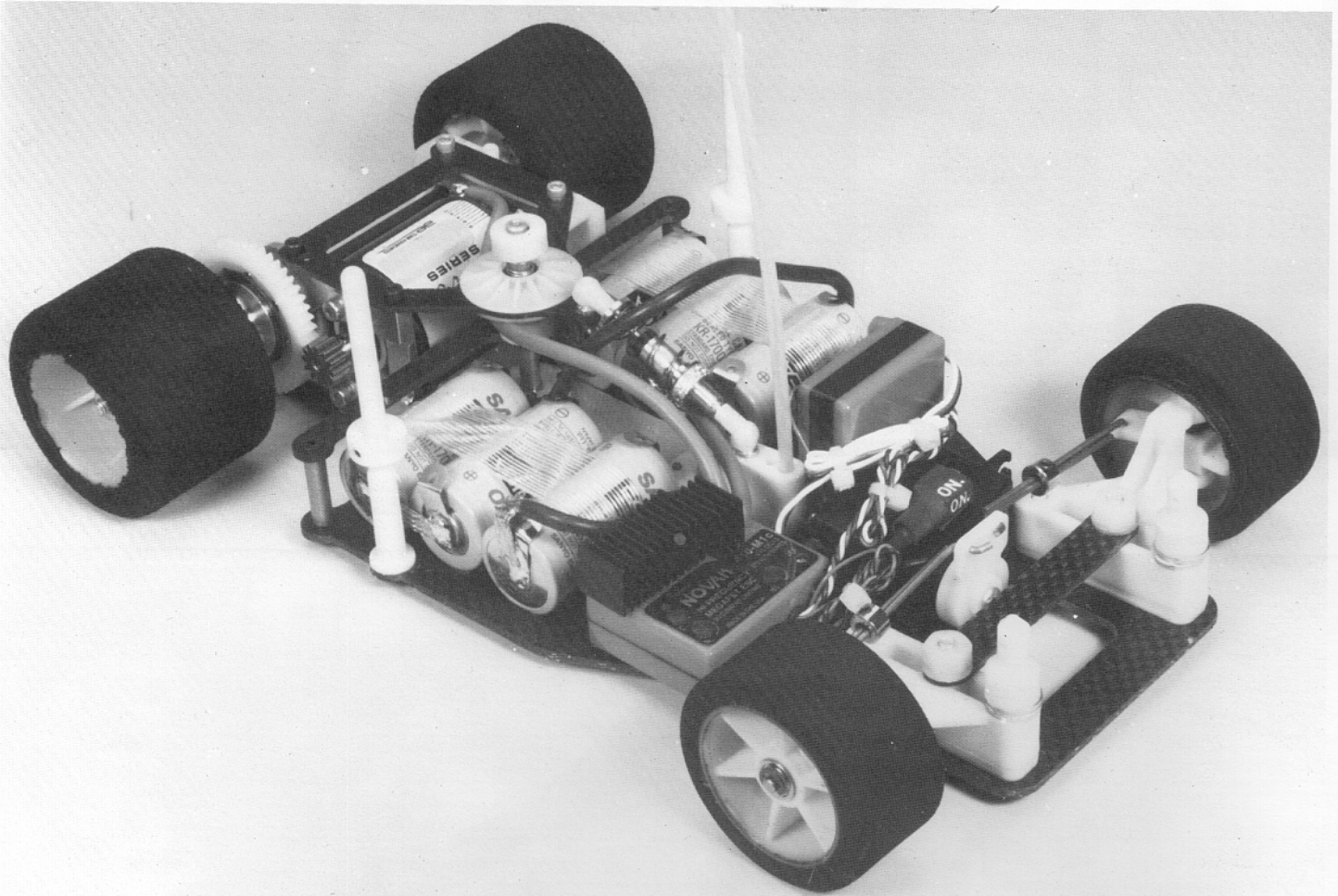

CAUTION

Ni-Cd batteries are susceptible to damage when overcharged at a high rate, and can release caustic chemicals if the overcharge is severe. **Read the battery charging instructions in this manual before attempting to run your car.**

Do not stall the motor under power. If the car stops suddenly on the track, or fails to move forward when you attempt to accelerate (after hitting a wall, for instance), push the throttle control on your transmitter to the brake position immediately and attend to the car. A small rock may have stalled the gears, and if the throttle is left in the "on" position, the result can be a burned-out motor or resistor or electronic speed control unit.

If you run your car to the point where more than one cell in the pack is completely discharged, **it is possible to lose radio control of the car** before the drive motor stops completely. For this reason you should not operate your car in an area where it could be damaged or cause harm to others, such as near a pool of water or a busy roadway. Usually radio control will be regained as soon as you pull the car from the obstruction and the motor is allowed to free-run. If you still don't have control, then you should turn the switch off.

A partially burned-out or shorted motor can make the car appear to have radio problems. If the car slows down suddenly and the radio acts erratically even with a full battery charge, then the cause is probably the motor. Check the range of the radio. A shorted motor will draw extremely high current even under no-load conditions.

RC12LW is a trademark of ASSOCIATED ELECTRICS, INC.
©1991 ASSOCIATED ELECTRICS, INC.

FIRST, A WORD

CONGRATULATIONS!! You now have the best 1/12 scale car in the world! The RC12LW has followed along in the winning tradition of all Team Associated 1/12 race cars. Starting with the original RC12E, which won numerous National Championships, Associated then designed the RC12i, which won the very first 1/12 IFMAR World Championships in Anaheim, California, and then again won the next World Championships in Denmark. The RC12L followed in this winning tradition by taking 1st, 2nd, 3rd and 5th at the World Championships in Las Vegas, Nevada, including Top Qualifier honors.

The original design of the RC12L came from Gil Losi Jr.. Gil built the first prototype cars and proved their racing ability. With Gil's participation, Associated further developed the car. The new RC12LW was basically named by our Team that raced the car at the IFMAR World Championships in Singapore. The racers called it the WORLD'S car, hence the official designation RC12LW, or World's car for short.

The new RC12LW varies from the original RC12L in the placement of the weight in both cars. The RC12LW has had the battery weight moved closer to the centerline of the chassis and/or car which results in a car with more responsive steering, which is most apparent in the "S" sections of tracks. This necessitated a redesign of half of the parts of the car, as well as adding a shock absorber.

Did this help the handling of the car? Our Team told us it was a lot better and then went out and took 1st, 2nd and 3rd, as well as Top Qualifier honors, at the IFMAR World Championships in Singapore. You have the best car in the world.

CHASSIS PREP

Fig. 1—There are two RC12LW kits made, the #4405, which is a fiberglass chassis kit, and the #4406, which is a graphite chassis kit. Those of you who have the fiberglass chassis can always update to the graphite chassis at a later date. The chassis are fully interchangeable.

Although these instructions show only the graphite chassis (the black chassis), the fiberglass car is assembled in exactly the same way these instructions show.

To begin, take your chassis, graphite or fiberglass, and notice that the BOTTOM of the chassis has the holes countersunk for screw heads. On the TOP of the chassis we want to file the eight battery slots at the small angle Fig. 1 shows so the battery cells will not be against a sharp corner that could possibly cut through the battery sleeve. Lightly file both sides, front and back, of all eight slots so the battery cells have a flat surface to seat against. (Fig. 79 shows how the cells are seated in the chassis.) You'll also want to file the edges of the chassis where the strapping tape holding in the batteries touches the chassis. Just round these corners so they can't cut the tape.)

When you're finished, wash off the chassis with running water and dry it with paper towels, and then wash your hands off with soap and water. Dispose of all the filings.

You're now finished with Fig. 1, so put a check mark in the box next to "Fig. 1" to show this step is completed. After you've completed each step from now on, check off its box so you know which part of the assembly is completed. You won't miss any steps this way.

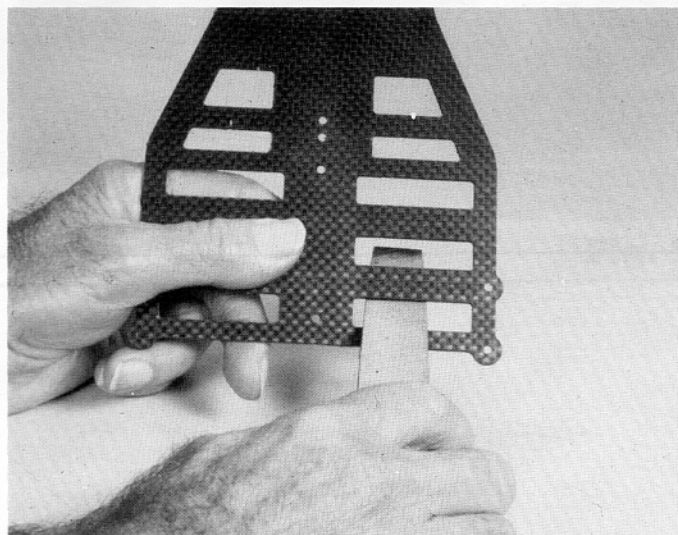

Fig. 1

SAVE THIS BOOKLET!

MORE THAN AN INSTRUCTION MANUAL, IT'S ALSO A HANDY, PICTORIAL SUPPLEMENT TO TEAM ASSOCIATED'S 1/12 SCALE CATALOG.

REFER TO THIS MANUAL FOR PART NUMBER AND NAME WHEN ORDERING.

FRONT END

□ **Fig. 2**—Empty Bag #1 into a paper plate. Take one of the #3213 front axles and push in one of the #3214 E-clips into the axle groove. (The E-clips are taped together and can be seen a little better in the photo.) Put another clip on the other axle. Now slip one of the small white nylon washers all the way onto the axles and up against the E-clip.

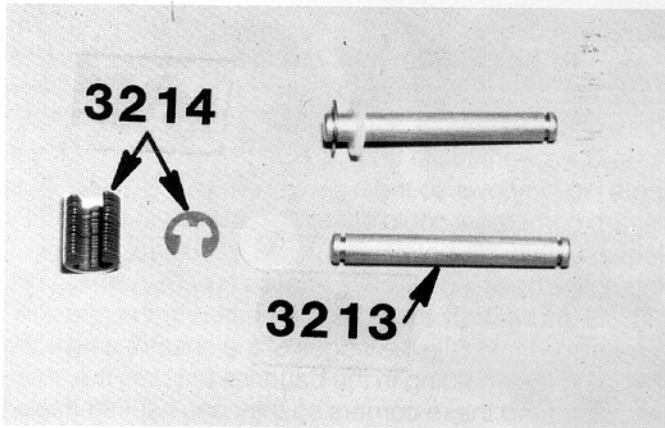

Fig. 2

□ **Fig. 3**—The axles should now look like this.

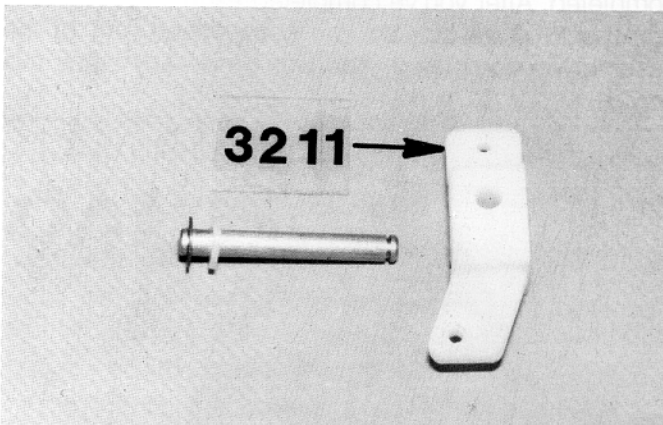

Fig. 3

□ **Fig. 4**—

Now tap the axles into the #3211 front steering blocks in the direction shown. The axle will go in tight, so support the steering block before driving the axle in. Support it by using a board with a small hole in it, or a vise. Set the block on top of the vise and drive the pin downward through the slightly opened jaws. Assemble both blocks. Your front blocks so far should look as shown.

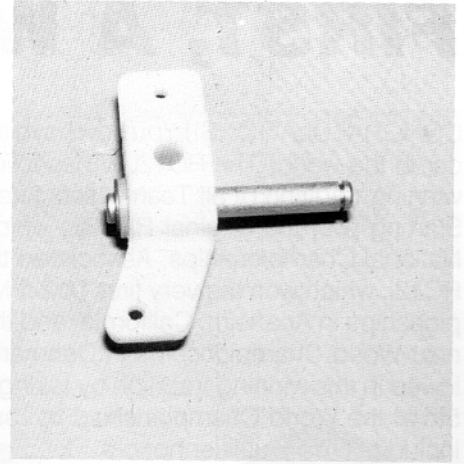

Fig. 4

□ **Figs. 5 & 6**—Now we're going to join the steering block to the #4115 front suspension arms. Place the steering block in the arm as shown in Fig. 6; place a spring on top of the arm where shown. Slide the #4123 kingpin into the suspension arm holes through the steering block and spring. Now put an E-clip into each of the two grooves in the kingpin. It's easier to put the clip in the groove by the spring first, and then to put the clip on the bottom of the steering arm last. It will be a close fit but they will go on. Pushing them in with a small screwdriver seems to work best. Assemble both blocks. Make sure they're securely in the grooves.

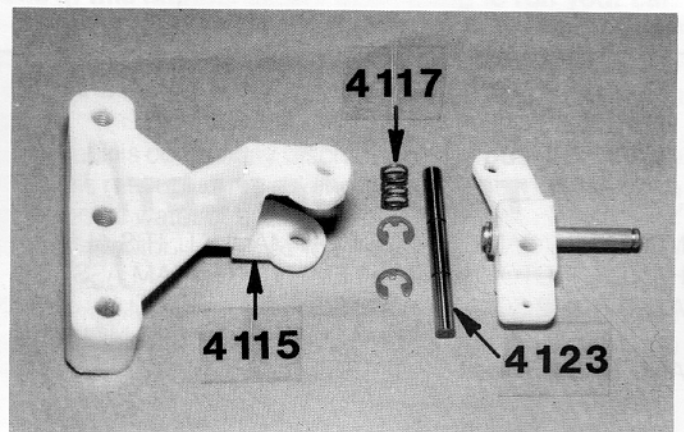

Fig. 5

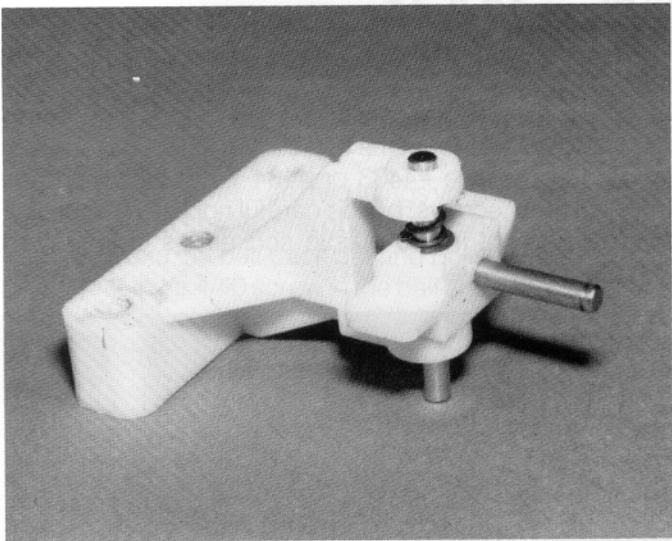

Fig. 6

□ **Fig. 7**—Now we mount the suspension arms to the chassis. The spacer goes on the chassis first, then the castor shim goes on (not shown in photo), and then the suspension arm goes on top of the shim. Make sure you've got the left hand side of the arm on the left hand side of the car and right hand side arm on the right side.

Use three aluminum screws to mount each arm. Screw in and tighten the screws.

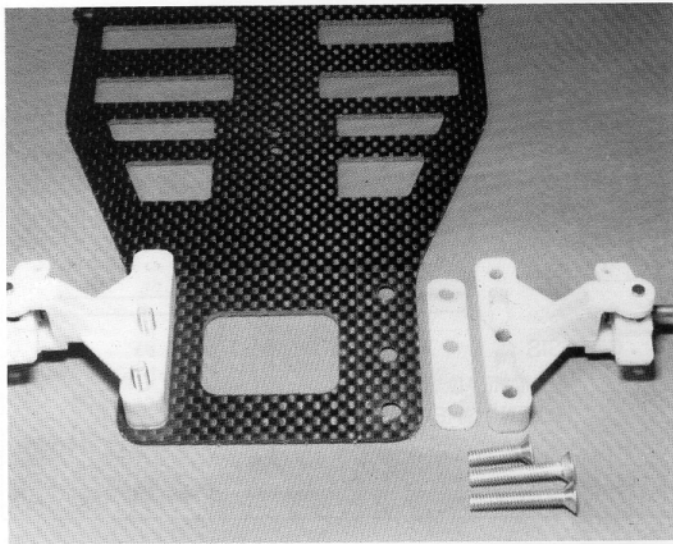

Fig. 7

□ **Fig. 8**—Open Bag #2. Mount the front body mounts onto the front screws. The height of the body mounts can be adjusted by washers according to the body you're using.

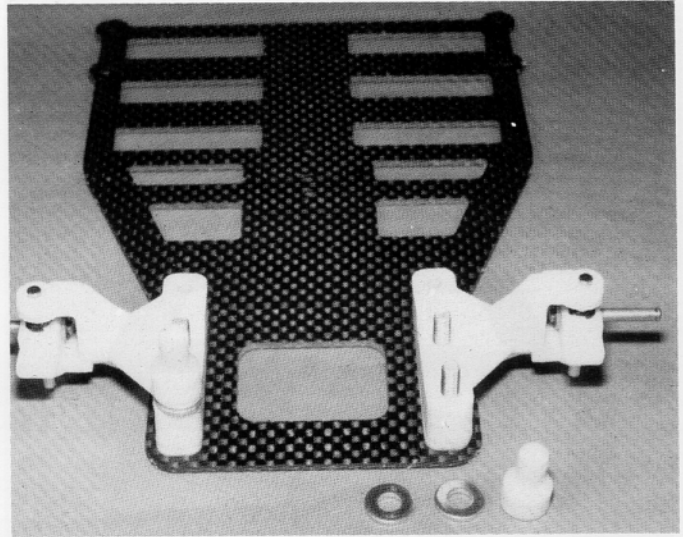

Fig. 8

□ **Fig. 9**—Now mount the #4430 suspension arm brace to both suspension arms using the nylon nuts. Do not overtighten the nylon nuts.

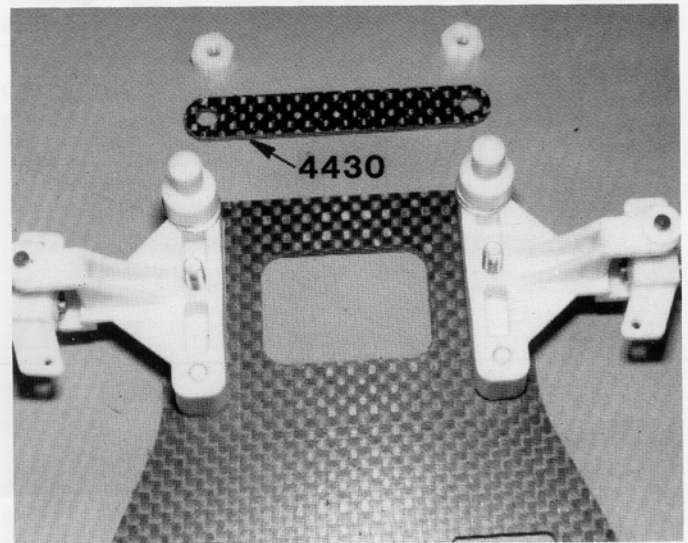

Fig. 9

□ **Figs. 10 & 11**—Your front end should now look like this.

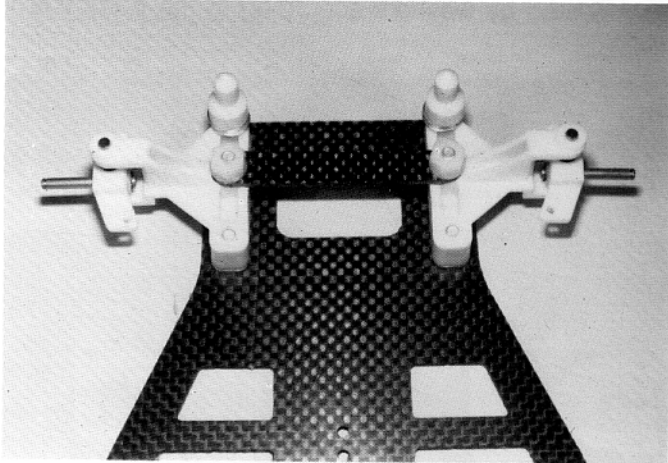

Fig. 10

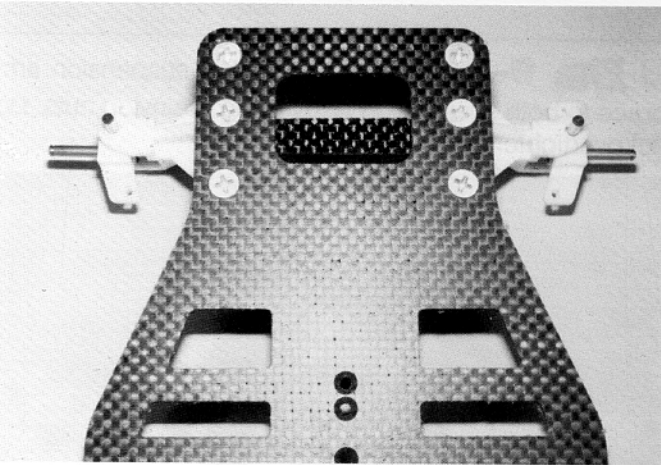

Fig. 11

□ **Figs. 12 & 12a**—From Bag #3 take the #4336 steel pivot ball and the #4335 plastic pivot socket and place the ball in one side of the socket, and then place the other half of the socket onto the ball and align all four screw mounting holes. Mount the ball socket assembly onto the forward end of the #4433 or 4434 T-bar where shown. Install the four screws, but be careful not to overtighten. If this ball is tight in the plastic socket, it's okay, it isn't supposed to swivel.

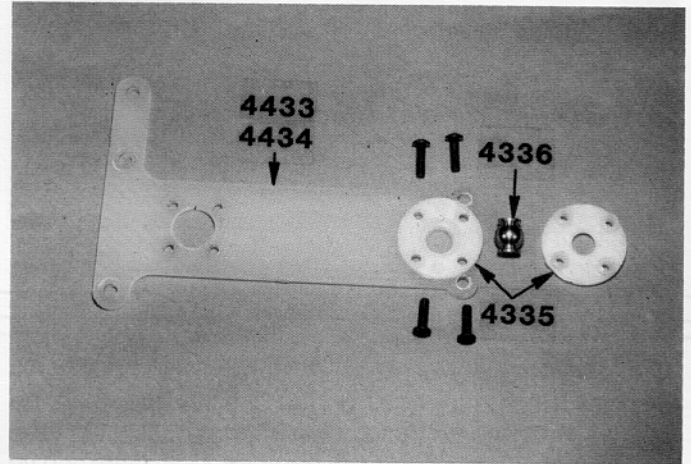

Fig. 12

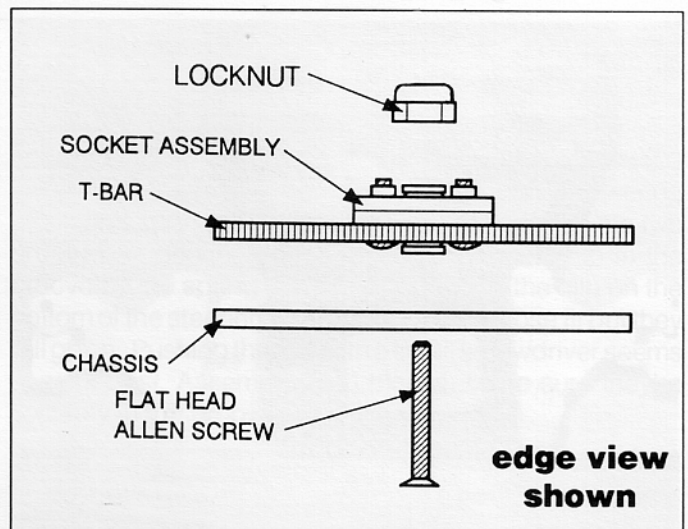

Fig. 12a

□ **Figs. 13 & 14**—Now assemble and mount the second rear socket assembly like you did the first one. Except in this socket, the ball **MUST BE VERY FREE, BUT NOT LOOSE**. Now see if the ball is **PERFECTLY FREE**. If it is, good, leave as is.

If it's not, there are two things you can do. You can unscrew all four screws one quarter turn. But the best thing to do is to take the ball back out and polish it. You can do this by placing a 4/40 screw in the ball and securing it with a nut and turning the screw in a drill press, polishing the ball with crocus cloth or #660 wet or dry sandpaper. Re-install the ball and make sure it's **PERFECTLY FREE**, but **NOT LOOSE**.

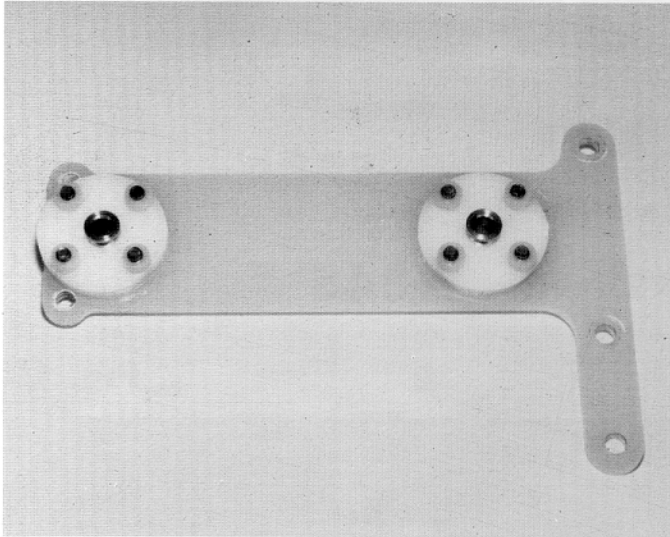

Fig. 13

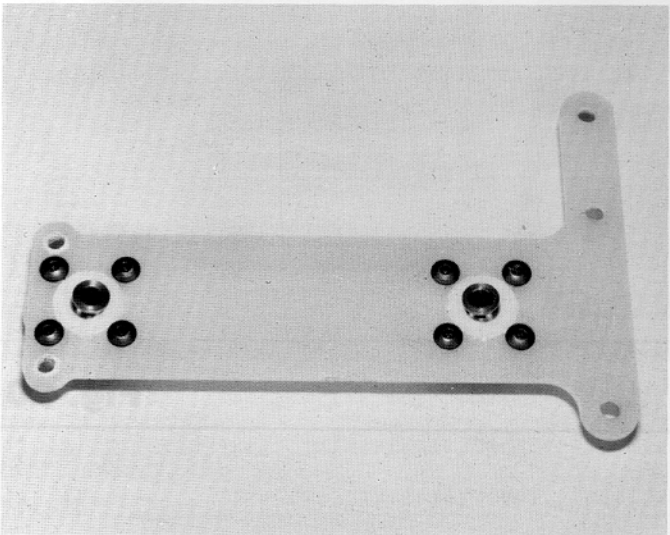

Fig. 14

□ **Fig. 15**—Install the two long set screws into the top of the T-bar where shown. Just screw them in far enough so they just start to come through the bottom side, but **NO MORE**.

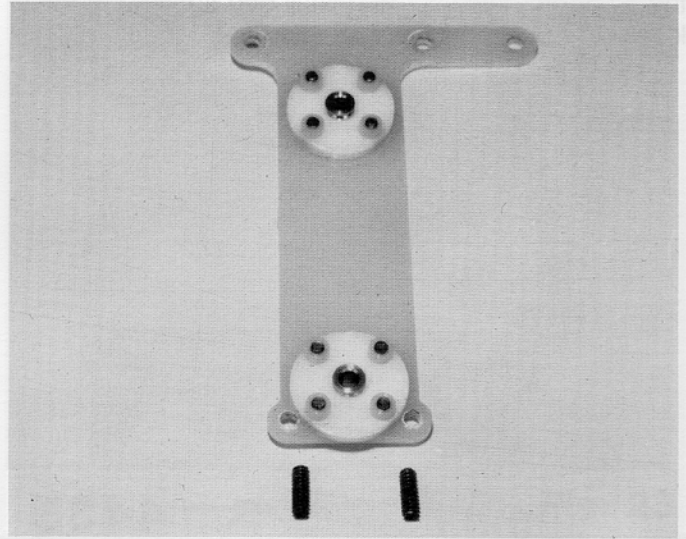

Fig. 15

□ **Fig. 16**—The two set screws you've just installed are called the **TWEAK SCREWS**. These are **VERY IMPORTANT**. We'll be coming back and adjusting these after the car is completely assembled.

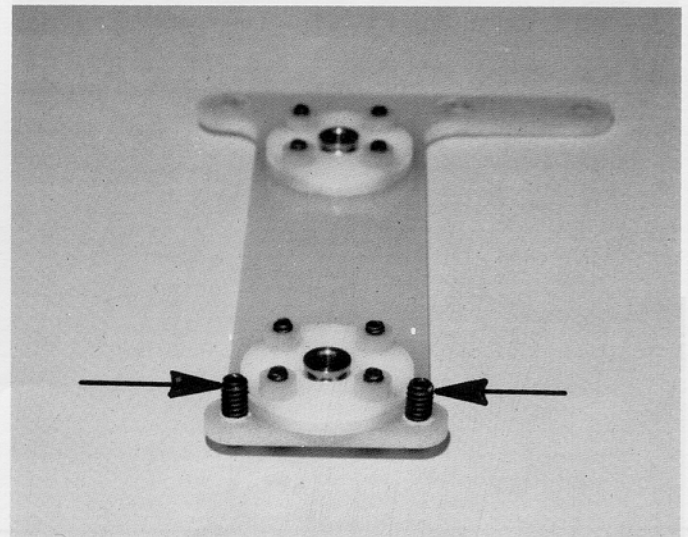

Fig. 16

□ **Figs. 17 & 18**—Install the T-bar assembly on top of the #4427 lower brace as shown. Push the three flat head screws up through the bottom of the lower brace and then slip the spacer down onto the three screws. Then slip the T-bar onto the screws. Install and tighten the three locknuts.

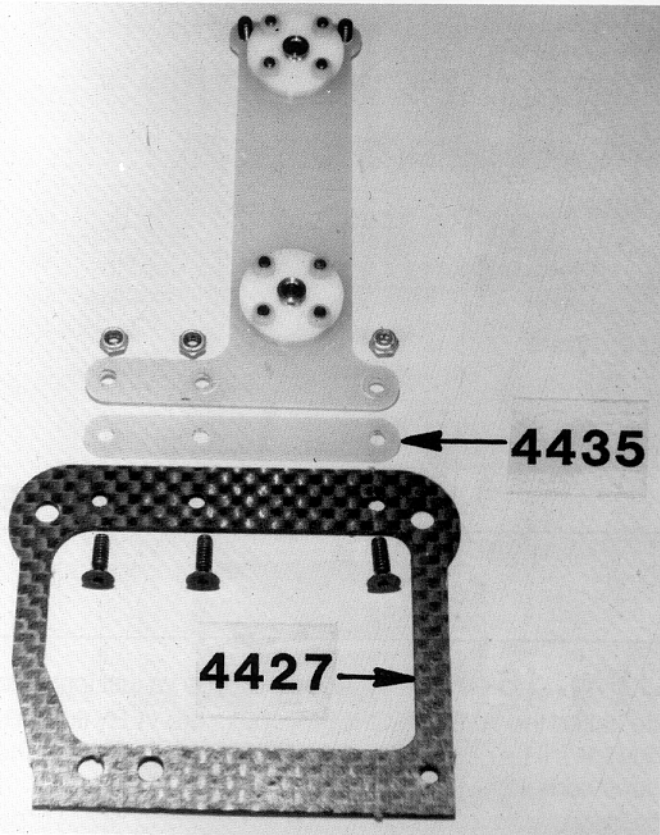

Fig. 17

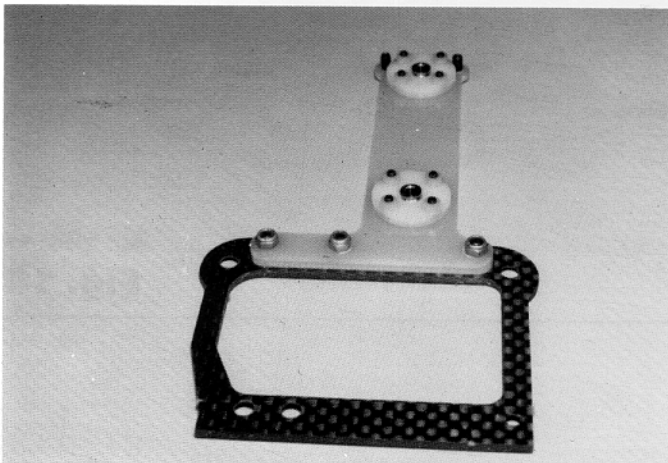

Fig. 18

REAR END

□ **Figs. 19 & 20**—Open Bag #4. Install the left hand #4345 bulkhead onto the lower brace with the three flat head aluminum screws as shown. Do not overtighten.

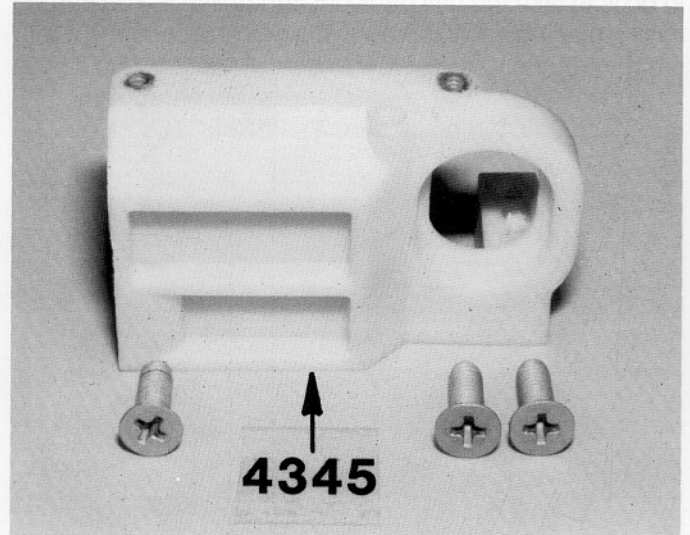

Fig. 19

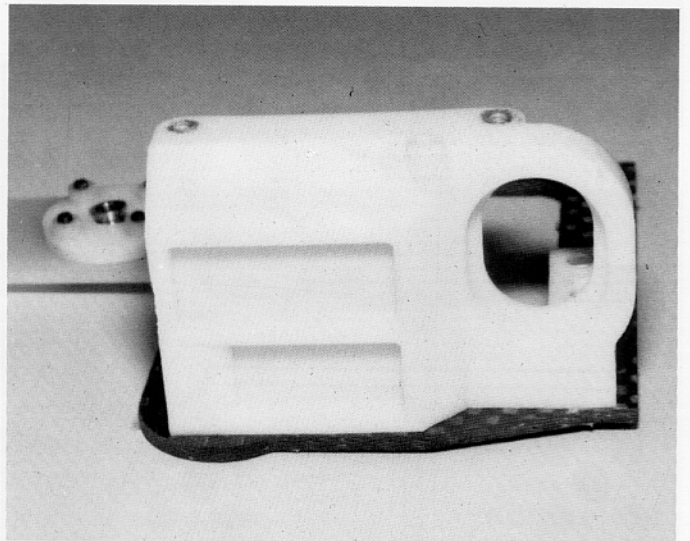

Fig. 20

□ **Figs. 21 & 22**—Install the right hand #4347 aluminum bulkhead onto the lower brace as shown. If you have the fiberglass kit, install the right hand #4346 plastic bulkhead with the three aluminum screws.

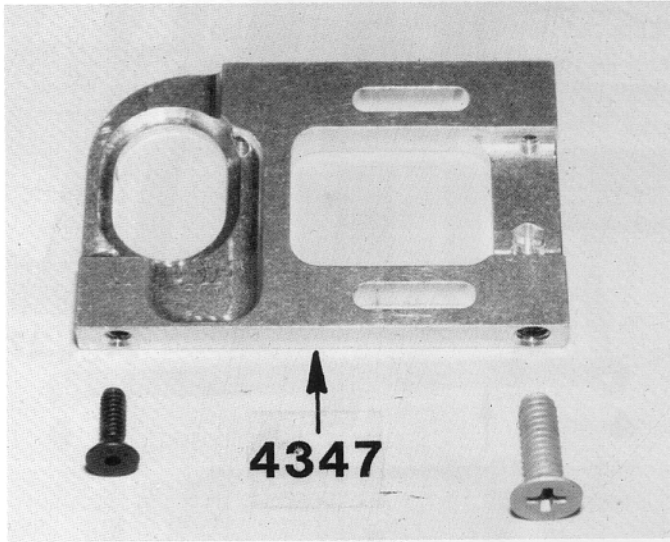

Fig. 21

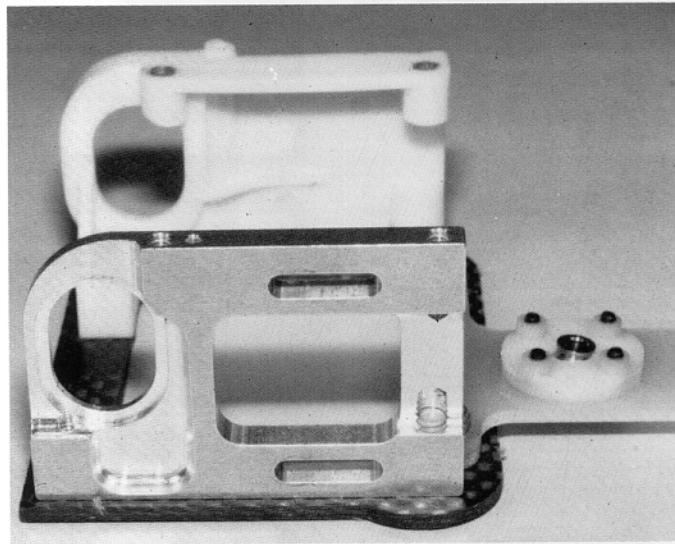

Fig. 22

□ **Fig. 23**—The bottom of the rear end assembly should look like this now.

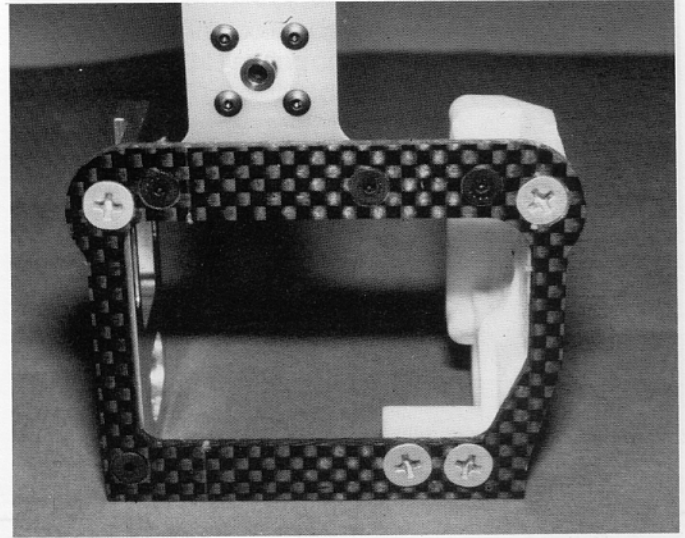

Fig. 23

□ **Figs. 24 & 25**—Take the #4349 plastic axle bearing height adaptors, the ones with the ball bearing holes centered in the adaptor, and install the adaptors in the left hand and right hand bulkheads, as shown. Now install a #897 ball bearing in each adaptor.

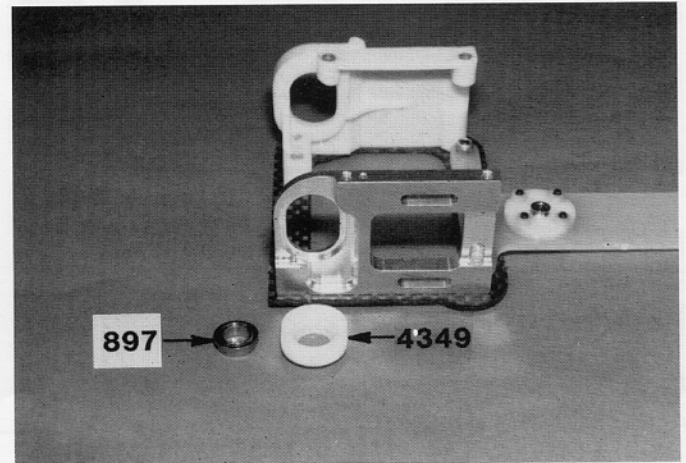

Fig. 24

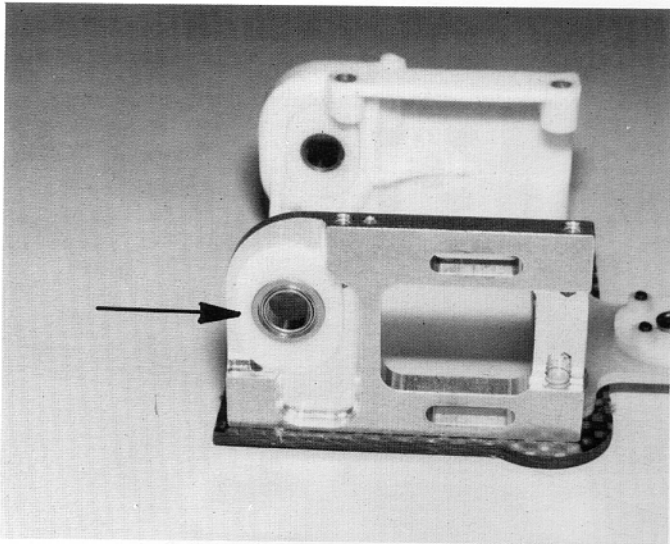

Fig. 25

□ **Figs. 26, 27 & 28**—Now we're ready to install the rear end assembly onto the chassis. Slip the short screw up through the forward hole in the chassis, then slip the T-bar down onto the screw, install and tighten the locknut.

Slip the long screw up through the chassis and the rear ball, thread the shortest aluminum tube down onto the screw, and tighten the screw. Now screw a little less than 1/2 of the set screw into the tube.

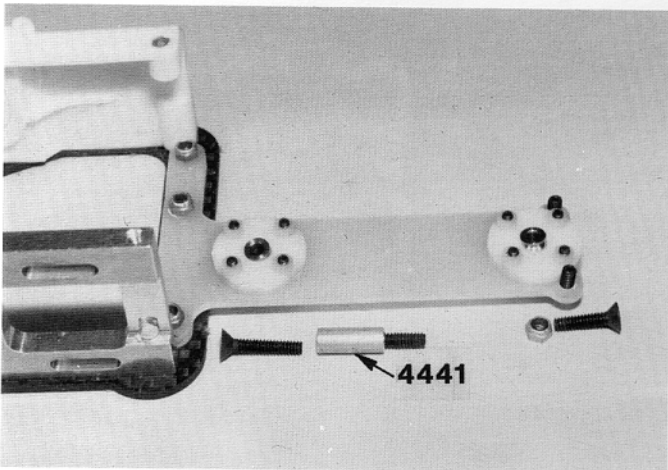

Fig. 26

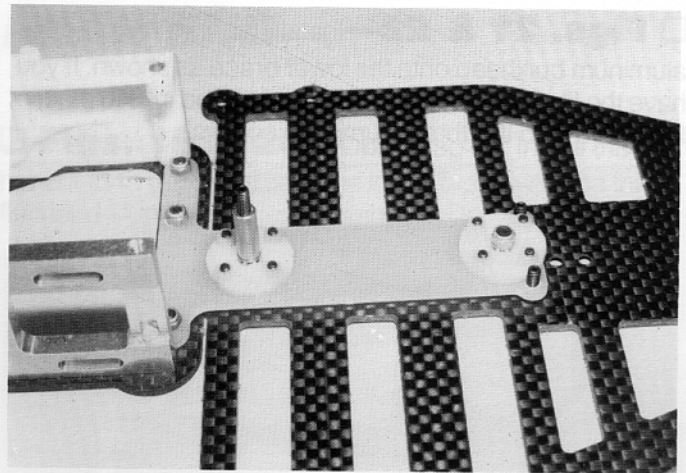

Fig. 27

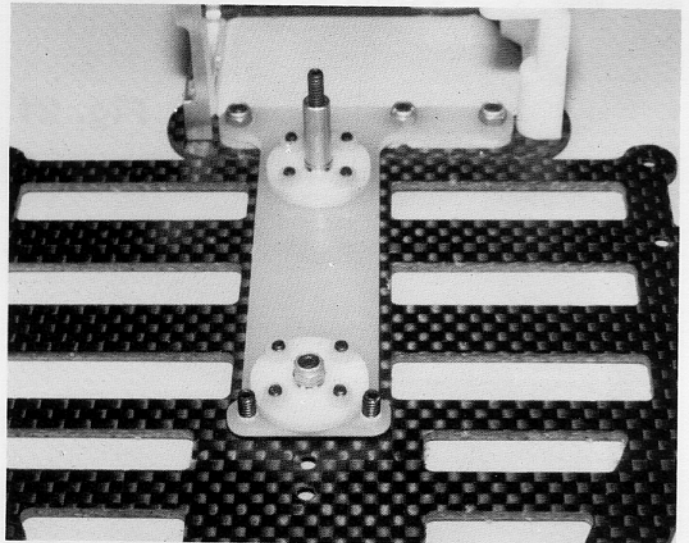

Fig. 28

□ **Figs. 29 & 30**—Time to install the rear #4428 brace. Open Bag #5. Install the two #4432 aluminum tube spacers to the chassis with the two short flat head screws shown, but do not tighten the screws yet.

Slip the brace down over the long set screw with the countersunk side up and then install the two short screws in the outer ends of the brace. Tighten all four screws now. Slip the longest aluminum tube onto the long set screw and tighten down with a pliers.

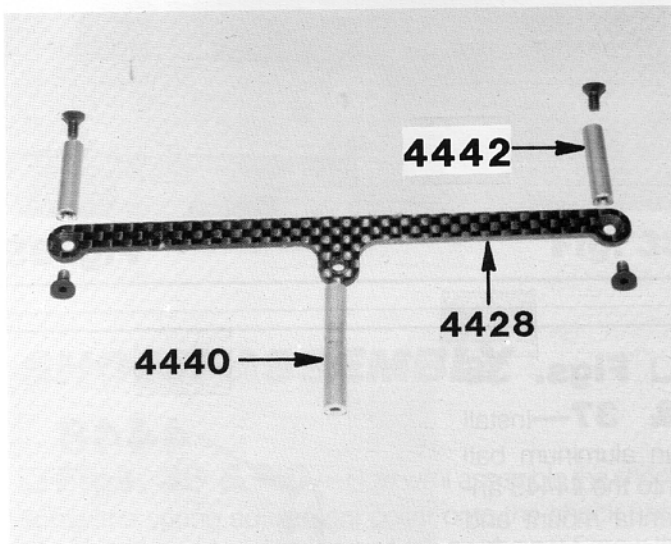

Fig. 29

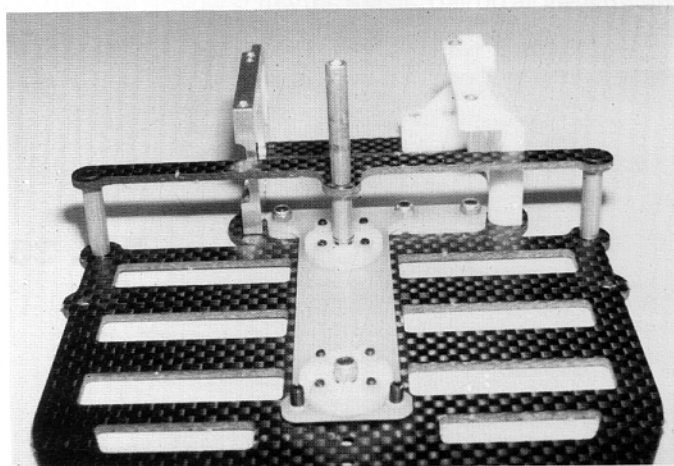

Fig. 30

□ **Figs. 31 & 32**—Open Bag #6. Take the #8330 black O-ring and push it into the hole in the #4340 dampner washer. Start a set screw into the #4338 locking collar and slip the collar down over the tube, as shown. Now slip the #4341 spring on and then the #4340 dampner washer with the smooth side of the washer up.

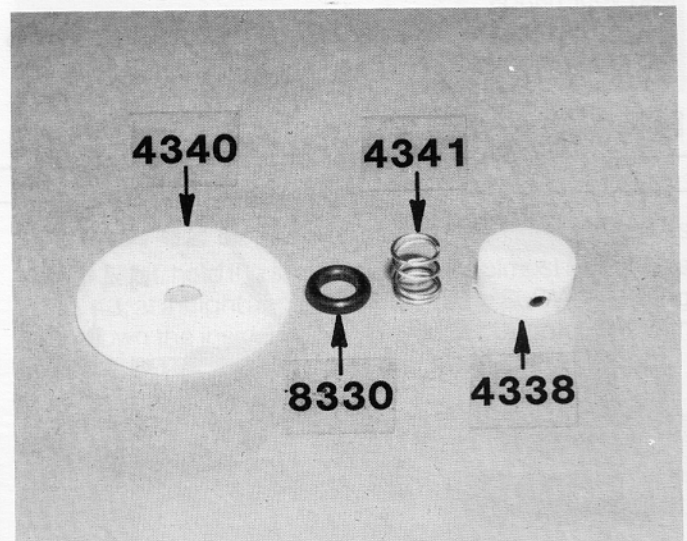

Fig. 31

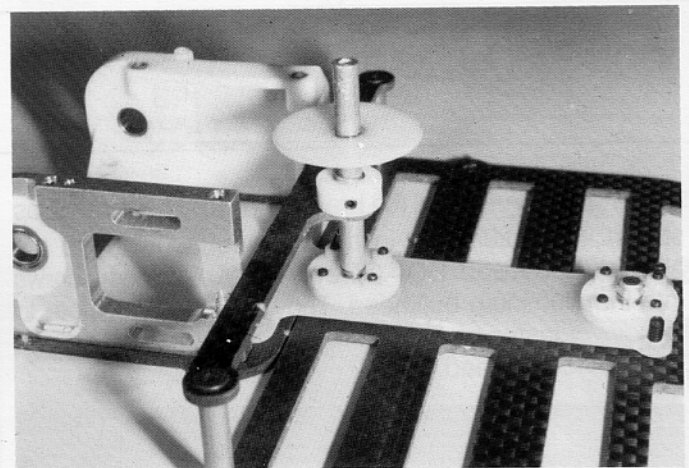

Fig. 32

□ **Fig. 33**—Take the #4426 upper bracket. The arrow is pointing where the dampner washers ride.

Racer's Tip: The Team racers will take some #600 grit wet or dry sandpaper and sand all the edges smooth here, so that the dampner washers slide freely over the bracket. Do this on the top and bottom. Clean the bracket and your hands.

Install an aluminum ball from Shock Bag #7 into the top of the bracket; tighten nut.

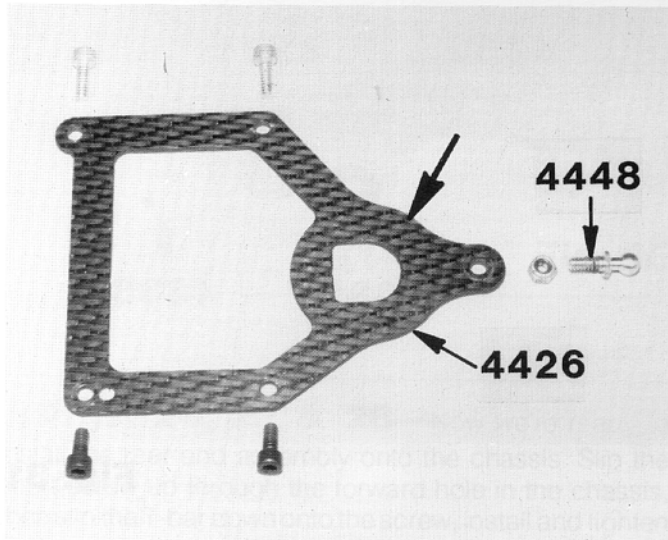

Fig. 33

□ **Fig. 35**—Install the upper dampner washer assembly, as shown.

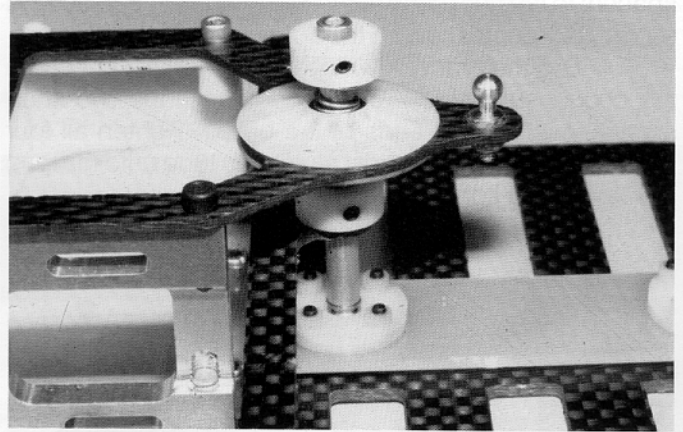

Fig. 35

□ **Figs. 36**

& 37—Install an aluminum ball into the #4443 antenna mount and then install the antenna mount to the chassis.

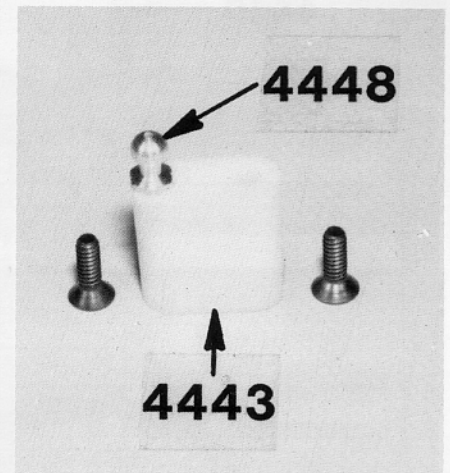

Fig. 36

□ **Fig. 34**—Install the bracket onto the bulkheads, as shown. Make sure you install the steel screws into the aluminum bulkhead. DO NOT ever install aluminum screws into the aluminum bulkhead. They will be impossible to remove or fasten securely. Install the aluminum screws in the plastic bulkhead. Do not overtighten.

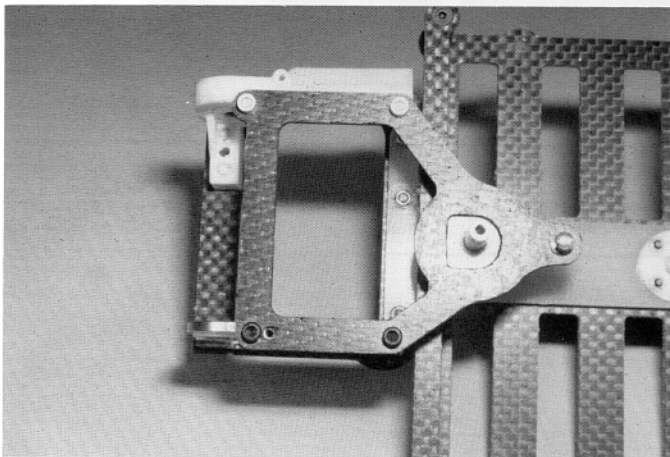

Fig. 34

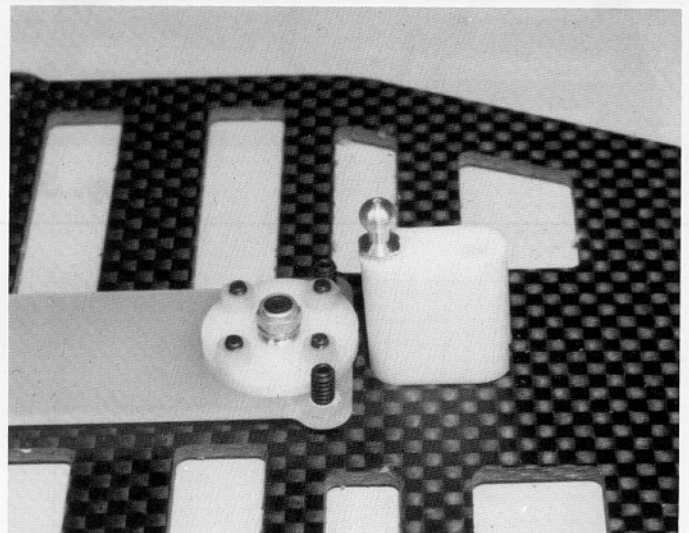

Fig. 37

□ **Fig. 38**—Take the two #6274 plastic ball cups and shorten both with an Exacto knife to the dimension shown.

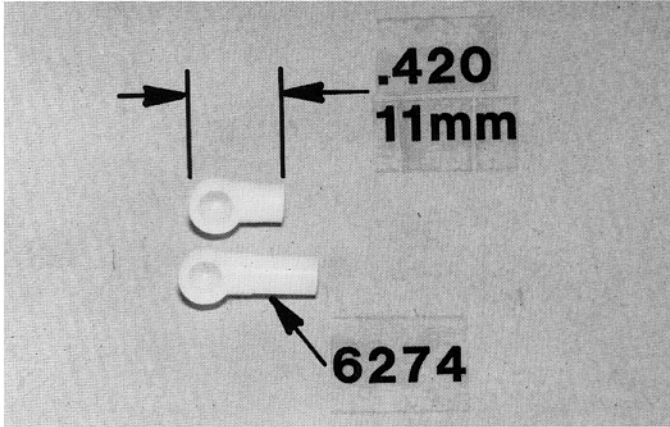

Fig. 38

SHOCK ASSEMBLY

□ **Figs. 39 & 40**—Now we'll assemble the shock. Screw the spring adjustment collar onto the shock body with the stepped end going on first, as shown. Screw the collar all the way on until it bottoms out, and then back it off two full turns. Now screw the plastic ball up all the way onto the threads.

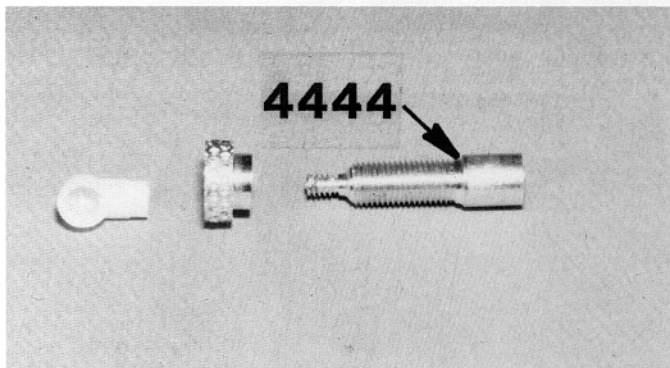

Fig. 39

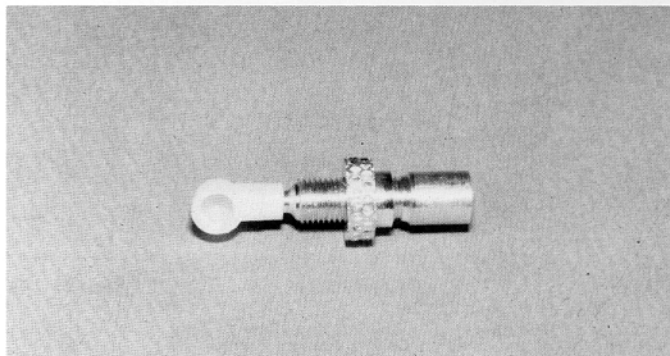

Fig. 40

□ **Fig. 41**—Slip the red O-ring onto the shock shaft and then slip the black plastic washer on.

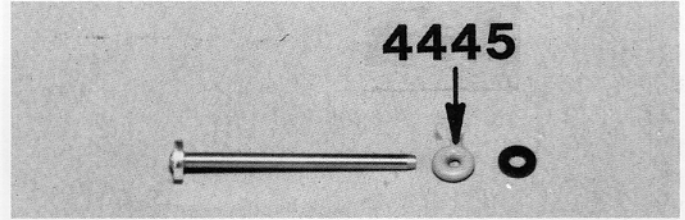

Fig. 41

□ **Figs. 42 & 43**—The parts go into the shock as shown. First, hold the shock body so it's almost upright, as in Fig. 43, at a slight angle. Put shock oil in SLOWLY, letting it run down the inside wall to prevent air bubbles. Fill with oil to the BOTTOM of the threads. Keep shock upright.

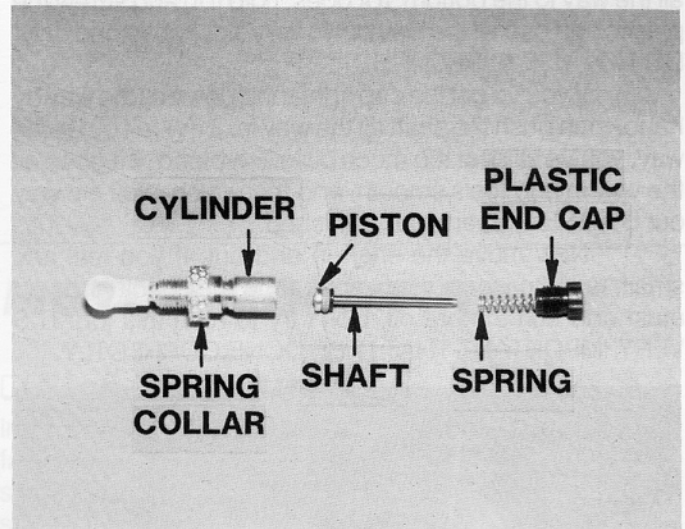

Fig. 42

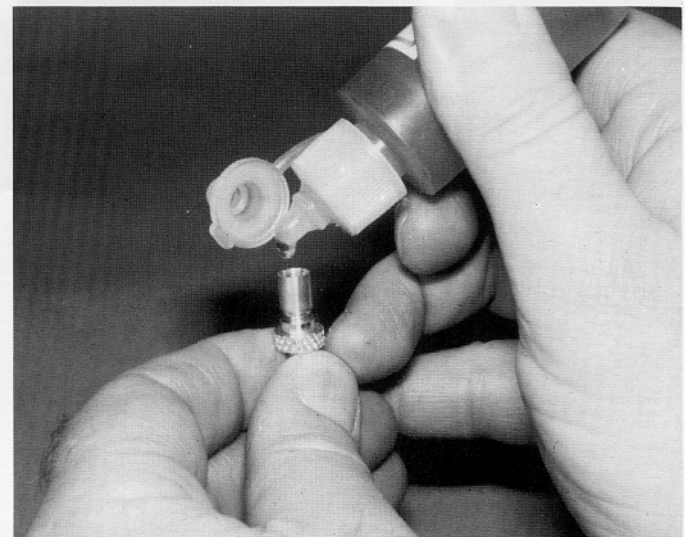

Fig. 43

□ **Figs. 44 & 45**—Push the piston and shaft assembly slowly down into the cylinder. Trim the flash off of the plastic end cap. Now slip the spring and plastic end cap onto the shaft. BE CAREFUL HERE. Screw the plastic end cap only two turns into the cylinder, SLOWLY, as shown in Fig. 44.

Now we must bleed the shock. THIS IS A VERY IMPORTANT PROCEDURE. There's no quick, easy way. It'll take a few minutes. Refer to Fig. 45. Push the shaft in VERY SLOWLY. We want to be able to push it all the way to the bottom. However, if there's too much oil in it, the shaft will not go all the way to the bottom. If there's too much oil, unscrew the plastic end cap while pushing the shaft in. It might be necessary to bleed some of the oil out. We're talking about a very small amount of oil here. Less than a drop.

If you've unscrewed the cap all the way, then you can push the shaft all the way in, and now re-install the plastic end cap two turns. Push the shaft. See if it will go all the way to the bottom. If it does, hold it in and screw the plastic end cap all the way down very slowly by hand only. DO NOT USE A WRENCH.

If you've got the cap tightened down all the way by hand, then push the shaft all the way in. If it won't go all the way, you've still got too much oil in. Re-bleed. If it goes all the way in and feels smooth, and then pushes all the way out BY ITSELF, then you're finished.

Now move the shaft in and out. If you feel any small, jerky motions, you've got air in the shock and you must add some more oil. Don't try to rush this job. IT'S VERY IMPORTANT THAT IT BE DONE CORRECTLY.

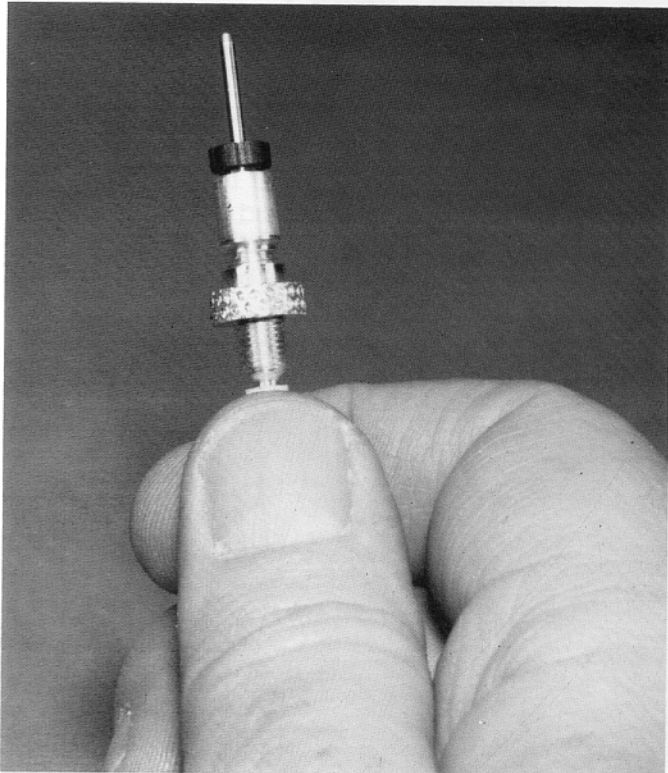

Fig. 44

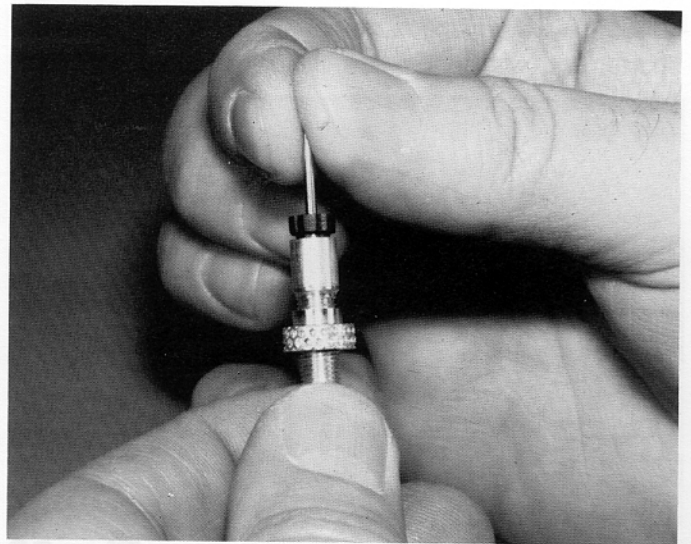

Fig. 45

□ **Figs. 46, 47 & 48**—Put a set screw into the shaft end and screw the plastic ball cup all the way on. Slide the # spring onto the shock. While holding the spring collapsed, slip the shaft end onto the shock shaft and securely tighten the set screw.

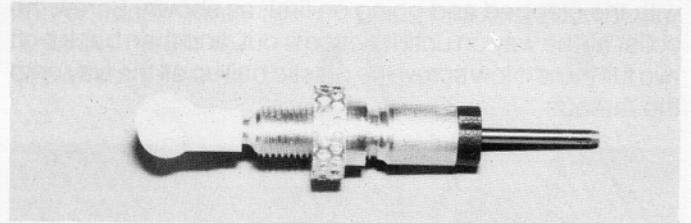

Fig. 46

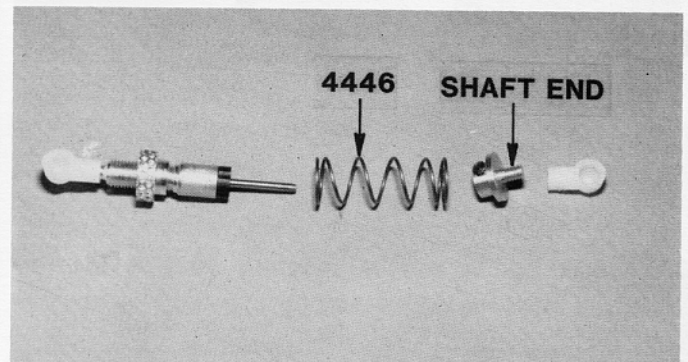

Fig. 47

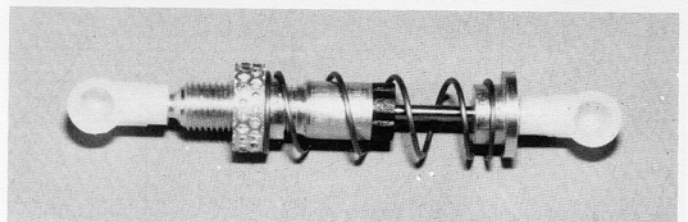

Fig. 48