

□ **Fig. 49**—Snap the shock onto the ball ends as shown.

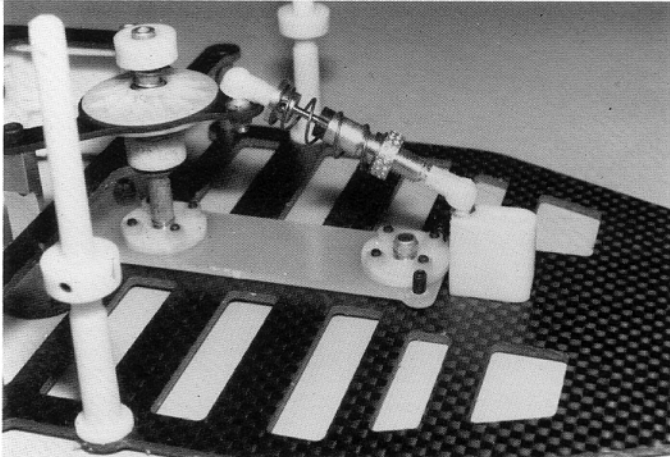

Fig. 49

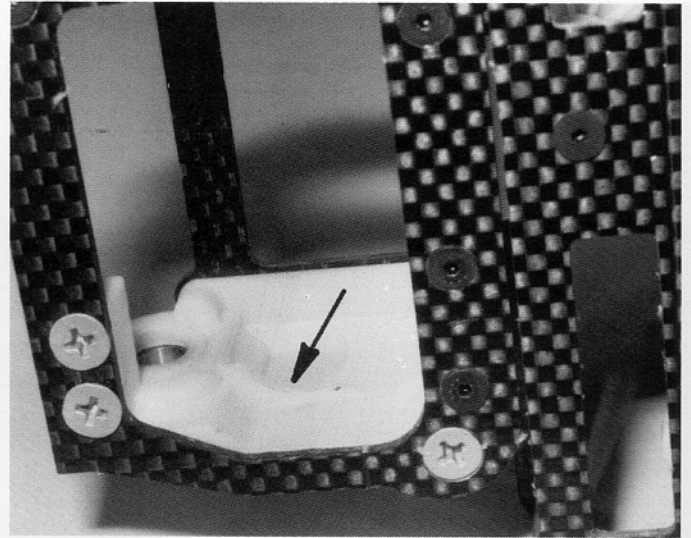



Fig. 51

□ **Figs. 50 & 51**—We'll need to trim some of the plastic away on the left hand bulkhead where shown in Fig. 50. Use a  knife and trim it approximately 1/8" off, as shown. It should now look like Fig. 51. This will allow us to install the motor much easier.

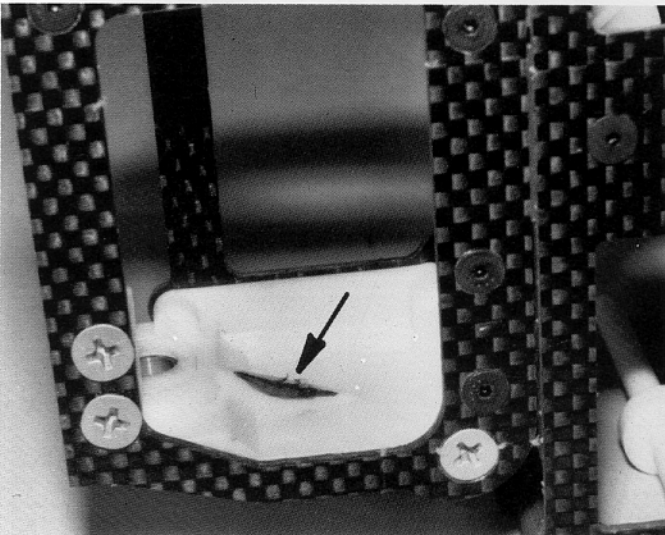

Fig. 50

MOTOR MOUNTING

□ **Figs. 52 & 53**—Before you install your motor, install the capacitors onto the motor that the motor manufacturer recommends to prevent radio interference. Now set screw the motor pinion gear onto the motor shaft as shown so that the end of the pinion gear is flush with the end of the motor shaft. Now slip the #8110 motor spacer onto the motor.

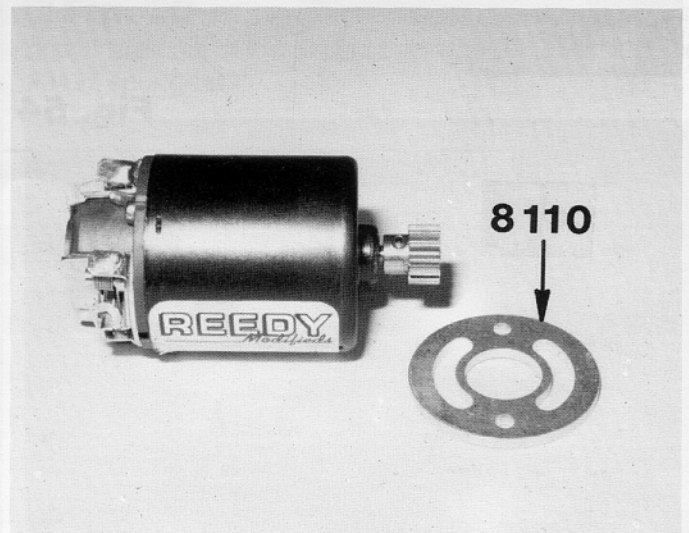

Fig. 52

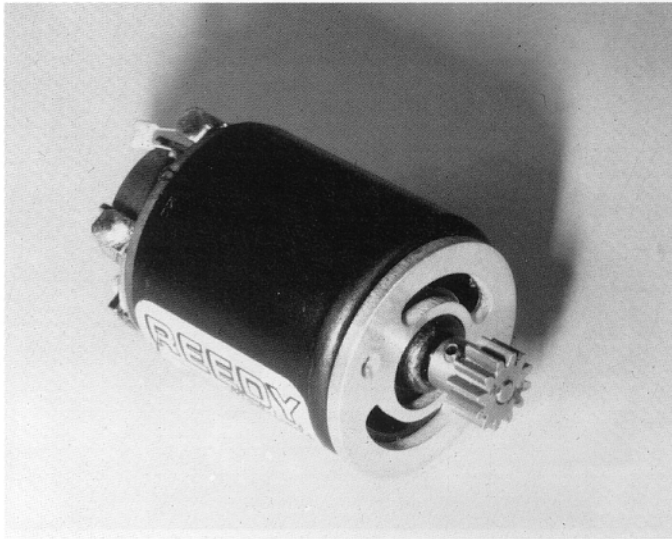

Fig. 53

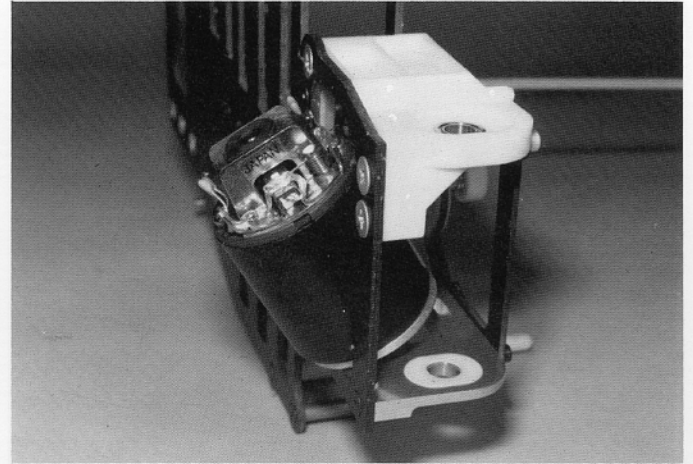

Fig. 55

□ **Figs. 54 & 55**—The motor is installed into the chassis through the bottom of the rear pod, as shown.

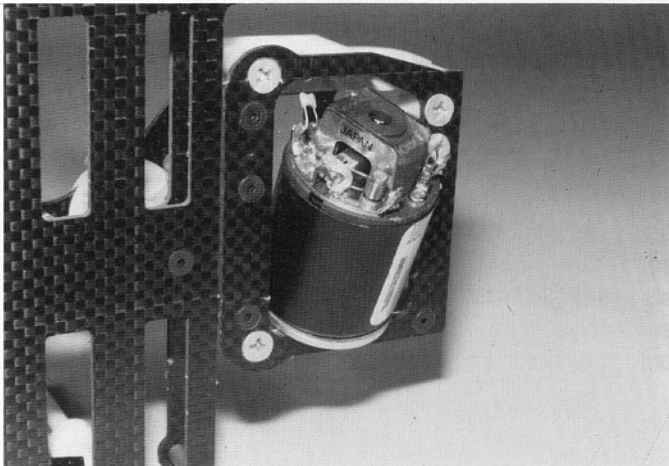

Fig. 54

□ **Fig. 56**—Install a washer on each motor mount screw and install the two screws loosely. They'll have to be adjusted later.

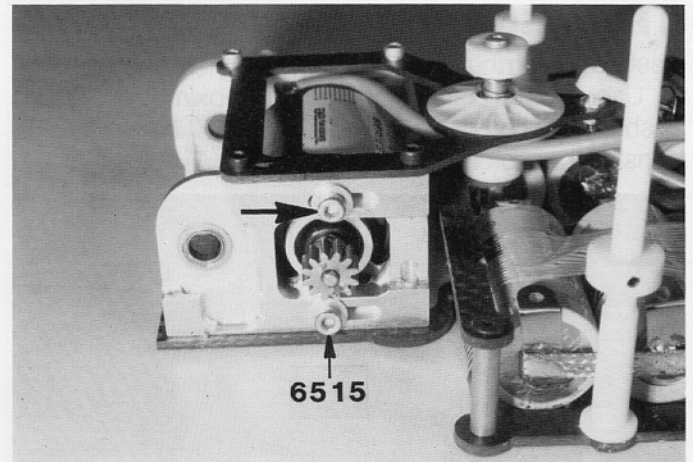

Fig. 56

FRONT WHEELS

□ **Fig. 57**—Take the front wheels and push a #3655 ball bearing into the inside and outside bearing pockets in each wheel.

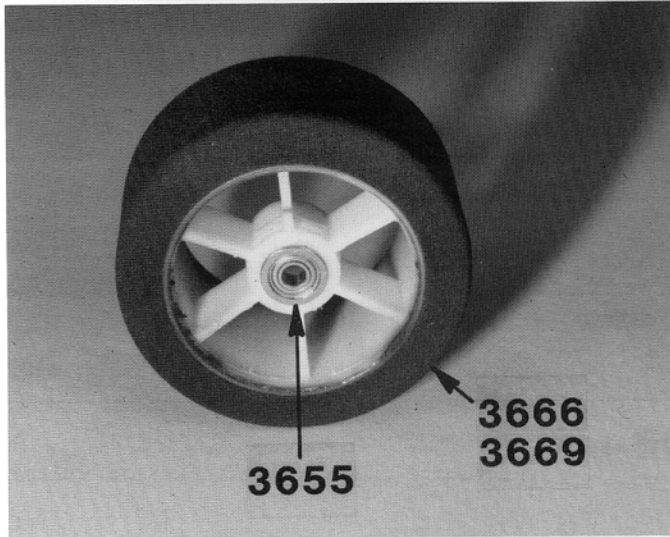

Fig. 57

□ **Figs. 58 & 59**—Slide a plastic washer onto the front axle, slide the wheel assembly on, then slide another plastic washer on, and install the E-clip. Make sure the E-clip is fully seated.

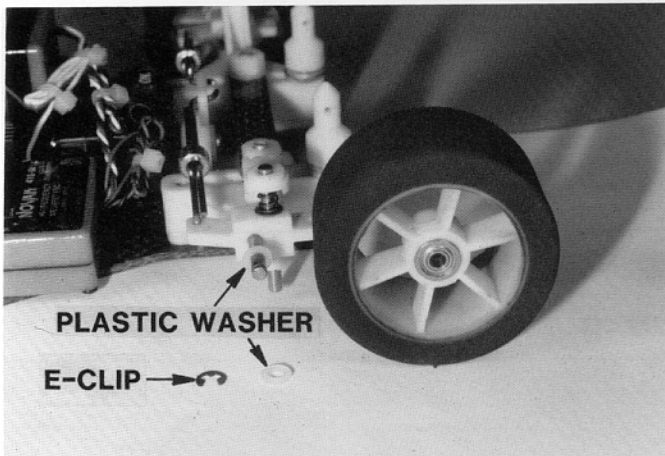

Fig. 58

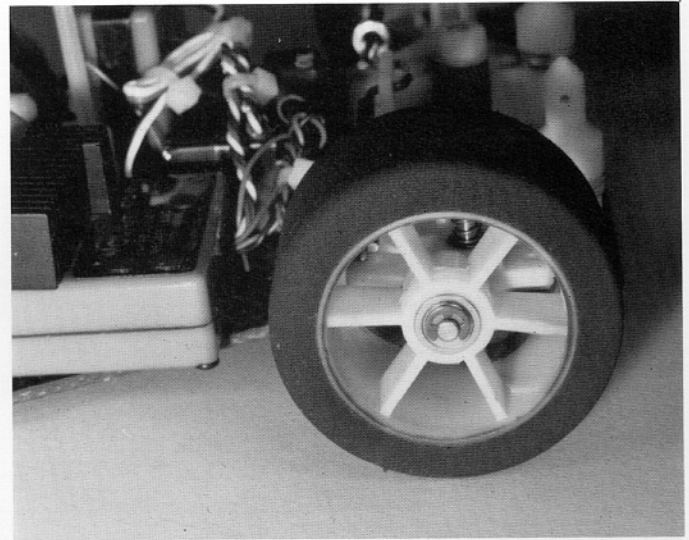

Fig. 59

DIFFERENTIAL

□ **Fig. 60**—Open Bag #8. Take the #3432 diff (differential) balls out of the plastic bag and pop them into the #3427 spur gear.

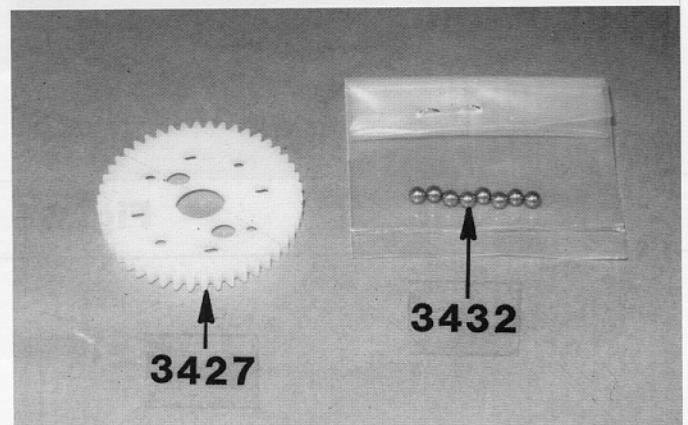

Fig. 60

□ **Fig. 61**—Take the #6636 diff lube and place a small amount on each ball on each side of the gear. **VERY IMPORTANT**—do not use any other kind of diff lube or grease on the balls, because your diff will not work correctly if you do. Our #6636 diff lube is a very special compound designed for our particular diff.



Fig. 61

□ **Fig. 63**—Slide the #4360 plastic ball bearing mount into the #4359 wheel spacer so that the thin end of the bearing mount goes in first.

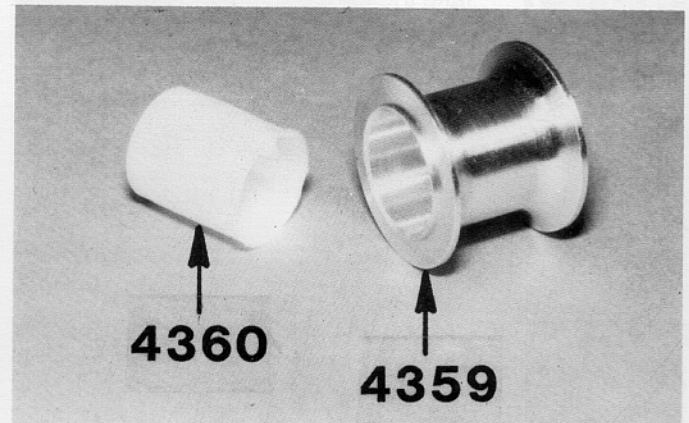

Fig. 63

□ **Fig. 62**—Slide and seat a #6625 drive ring onto the #4355 diff axle. It's easier to do if you hold the axle upright. Slip one of the #897 ball bearings onto the axle next, with the larger flanged end on first. This ball bearing must be able to slip into the #4360 ball bearing mount later.

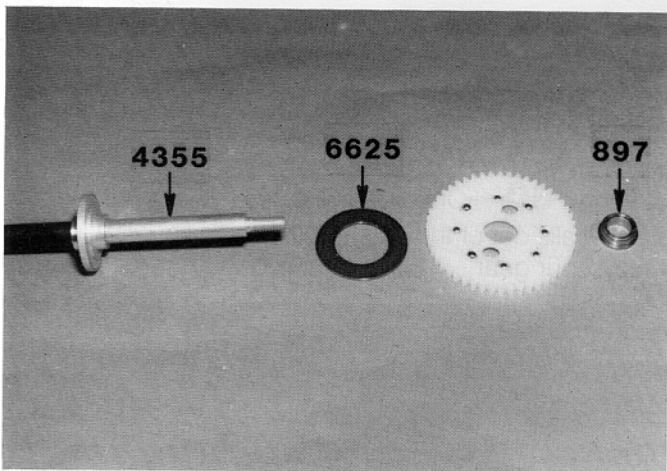

Fig. 62

□ **Fig. 64**—Slip another drive ring onto the axle and then slip the wheel spacer on. You'll have to center the drive ring so that the wheel spacer will seat correctly.

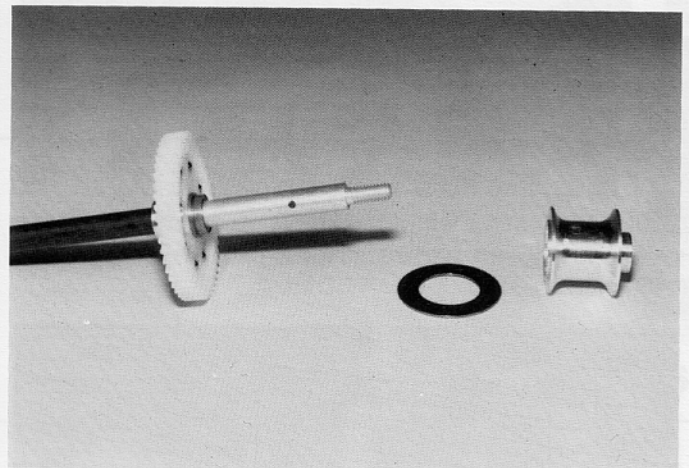

Fig. 64

□ **Fig. 65**—Push another #897 ball bearing into the RIGHT HAND ONLY rear wheel, as shown.

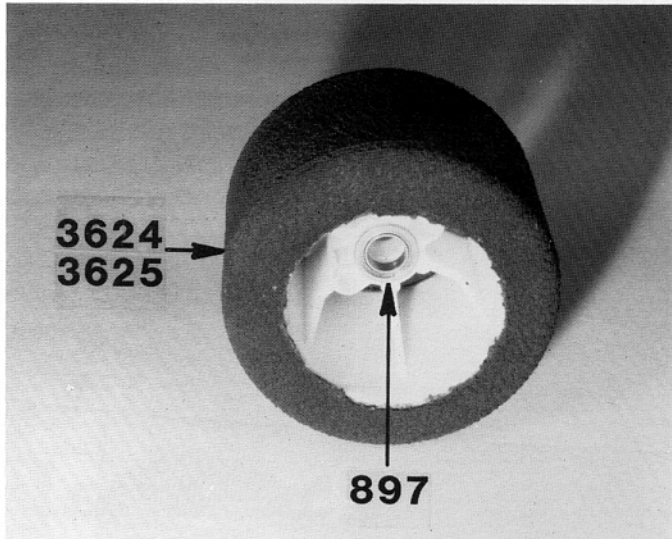

Fig. 65

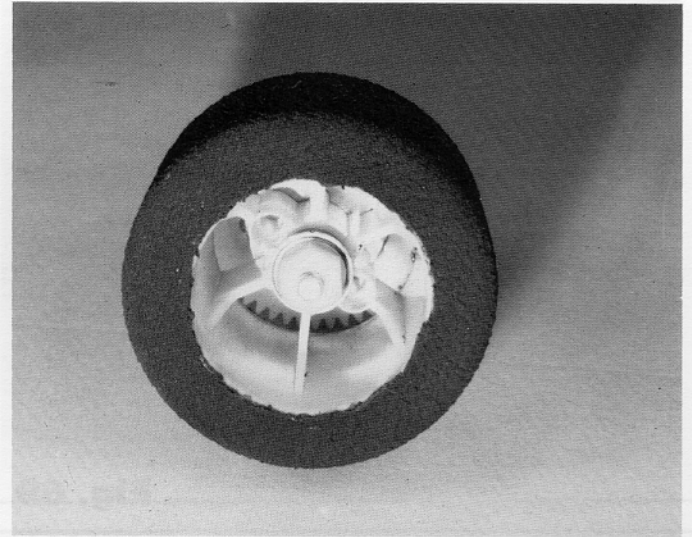

Fig. 67

□ **Figs. 66 & 67**—Slip the wheel on the axle. Now slip the tapered aluminum spacer on next, so that the smallest tapered end goes on first. Now slip the three tapered Belleville washers on next, so that the taper is pointing to the outside. Screw the nylon nut on and tighten by hand. Hold the axle in your left hand. Turn the wheel with your right hand. It should turn freely. If it doesn't, the drive rings are misaligned. We'll adjust the diff later.

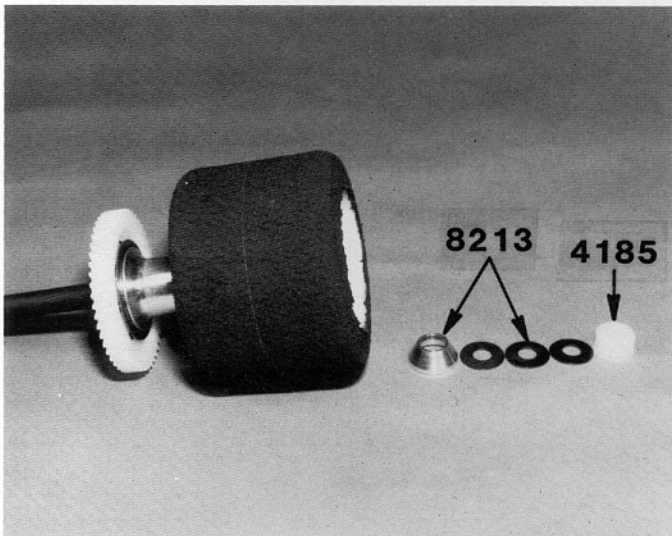

Fig. 66

□ **Figs. 68 & 69**—Slip a #8321 aluminum spacer onto the axle so that the stepped end of the spacer will be touching the #897 ball bearing in the rear pod. Slip the rear axle assembly into the rear pod, making sure the spur gear clears the pinion gear.

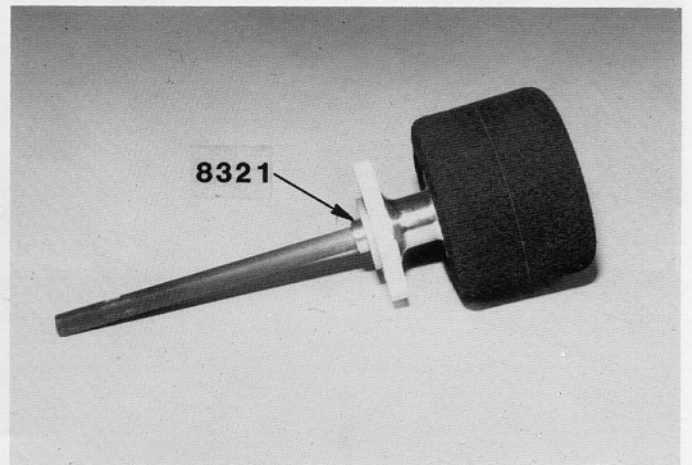

Fig. 68

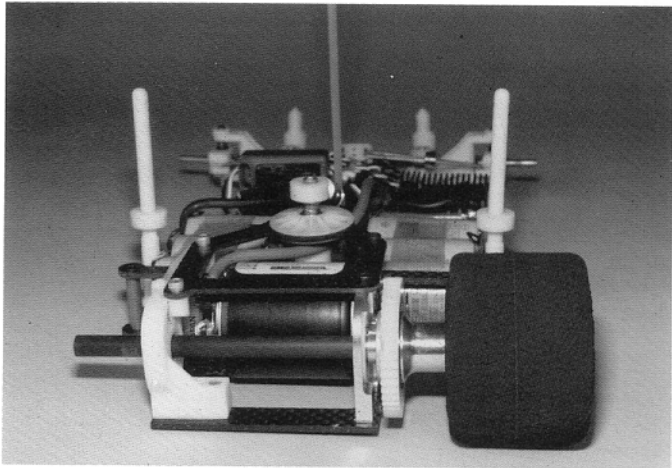

Fig. 69

□ **Figs. 70 & 71**—Install a set screw into the #3613 wheel hub and then install the wheel hub to the inside of the left hand wheel, as shown.

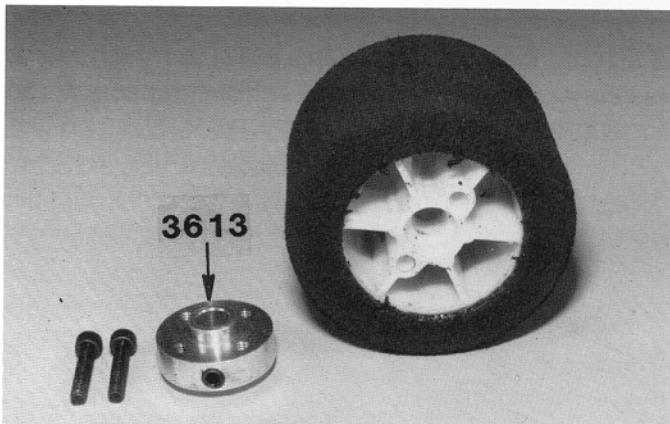

Fig. 70

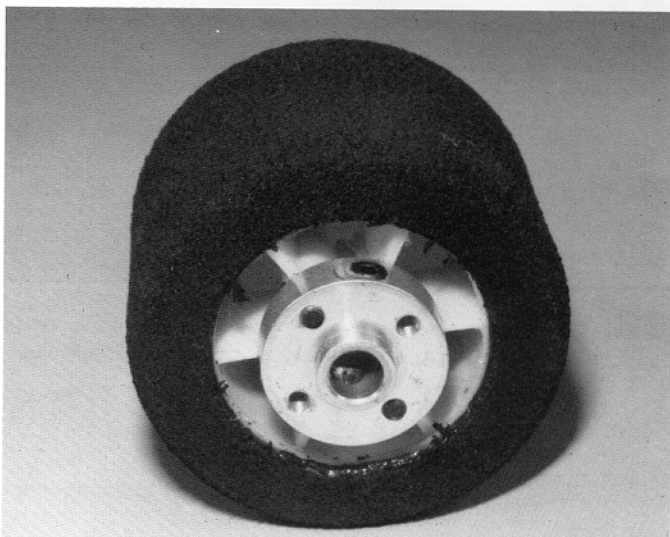

Fig. 71

□ **Fig. 72**—Slide the other #8321 aluminum spacer onto the axle so that the stepped end of the spacer will be touching the ball bearing. Slip the wheel on and tighten the set screw just enough to mark the axle.

Remove the wheel, spacer, and then remove the axle assembly from the pod and file a small flat spot on the axle where the set screw touched, as shown in the photo. This will make removing the axle later a little easier.

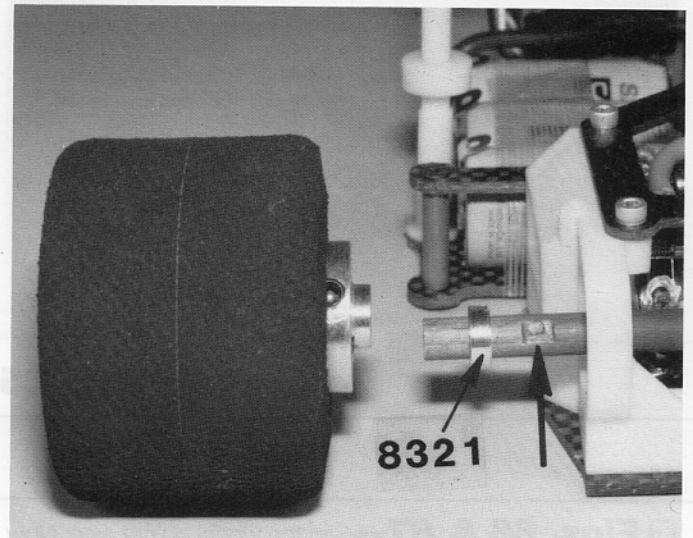

Fig. 72

□ **Fig. 73**—Re-install the axle, spacer and then the left hand wheel. Tighten the set screw lightly. We need a very small amount of end play. See if the axle will slide a very small amount to the left and right. If it will, tighten the set screw down.

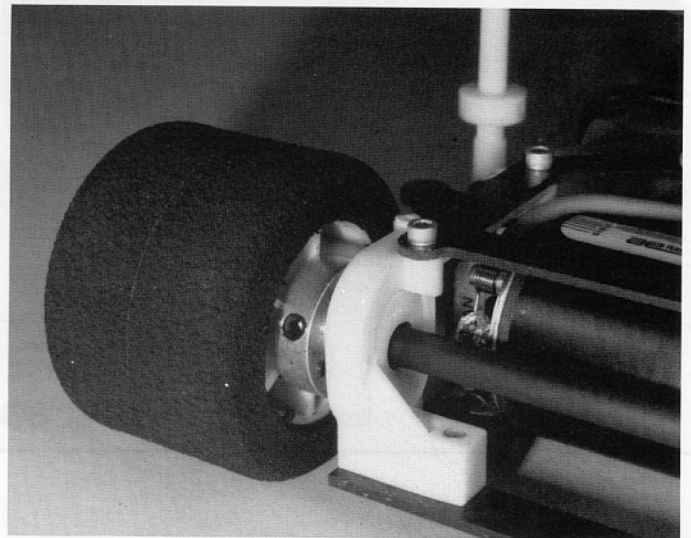

Fig. 73

□ **Fig. 74**—Now we'll adjust the diff. Hold the left hand wheel in your left hand and the right hand wheel in your right hand, as shown. Hold the wheels from turning. Take your right hand thumb, as shown, and push on the spur gear to see if you can turn it. If it will not turn, loosen the adjustment nut, shown in Fig. 67, until you can just barely push the gear forward. Now, tighten the nut just a very small amount. If you cannot push the gear forward now, then your diff is correctly adjusted.

Set the car flat on a table. Now refer back to Fig. 16 and very carefully screw down each tweak screw so it just touches the chassis and NO MORE.

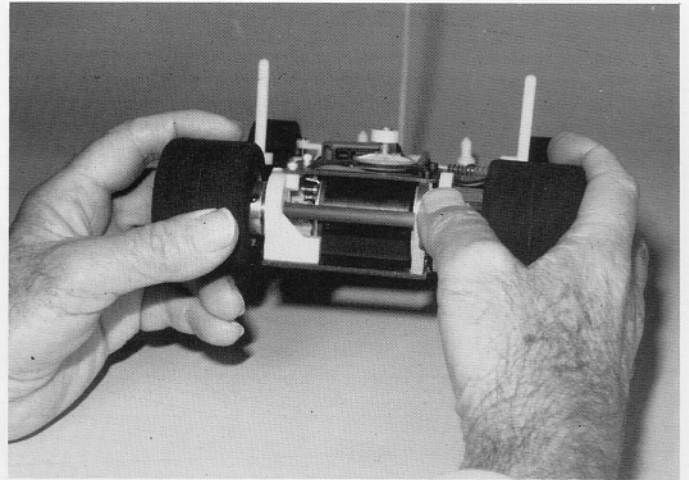

Fig. 74

ELECTRICAL

□ **Figs. 75 & 76**—We'll start with the steering servo. Line up the steering servo exactly as shown in Fig.

76 and attach it to the chassis with a piece of the black double stick servo tape.

Install the servo saver on the servo. Now install the #3752 tie rod linkage, as shown, with the set screws in the two locking collars aligning the front axles, as shown.

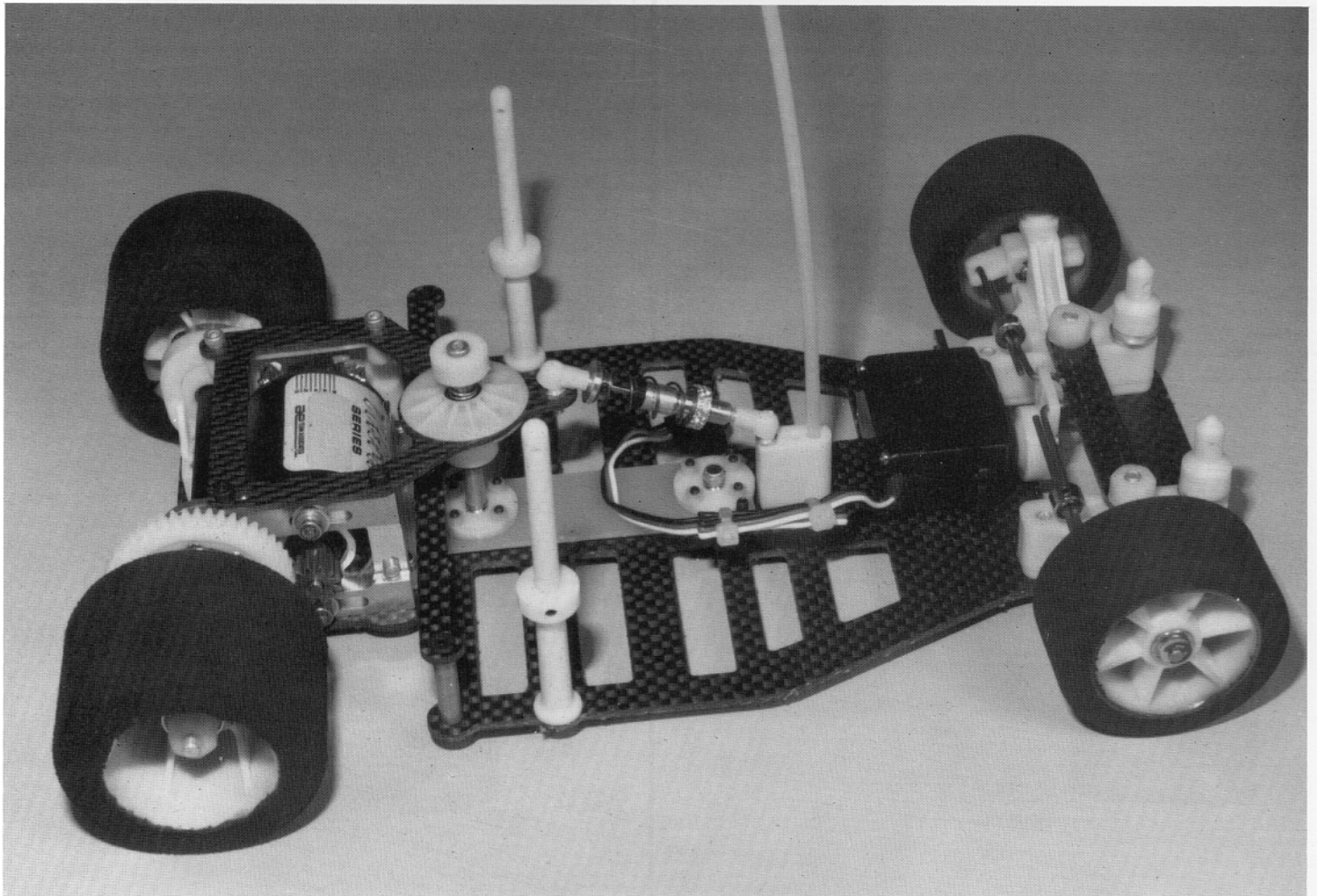

Fig. 75

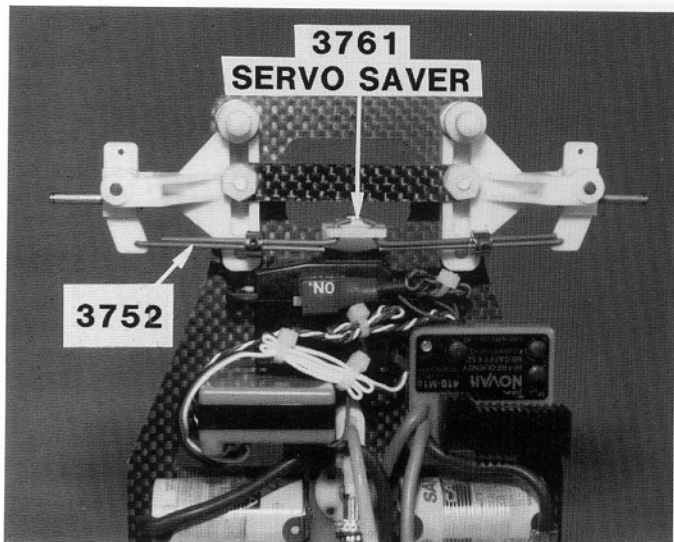

Fig. 76

□ **Fig. 77**—This step applies only to the graphite chassis. Graphite conducts electricity somewhat like metal, so for electrical purposes, think of graphite as metal. Because of its conductivity we need to make sure our batteries are properly insulated so they won't short out to the chassis. This step will not apply to you if you have a fiberglass chassis because fiberglass is already an insulator.

The shrink wrap on the battery cell is an insulator and we've filed the sharp edges off the chassis so it won't cut through it, but we still need to go one step further. We must add some black electrician's tape to the chassis where the pointer is showing in the photo. Add the tape to all eight ribs where the batteries touch. It's also VERY IMPORTANT to make sure none of our solder connections can touch the chassis anywhere.



Fig. 77

□ Figs. 78 & 79—

This shows the wiring diagram for a Novak ESC (Electronic Speed Control) out of the car and installed in the car. Other speed controls will install differently, so always go by the ESC manufacturer's instructions.

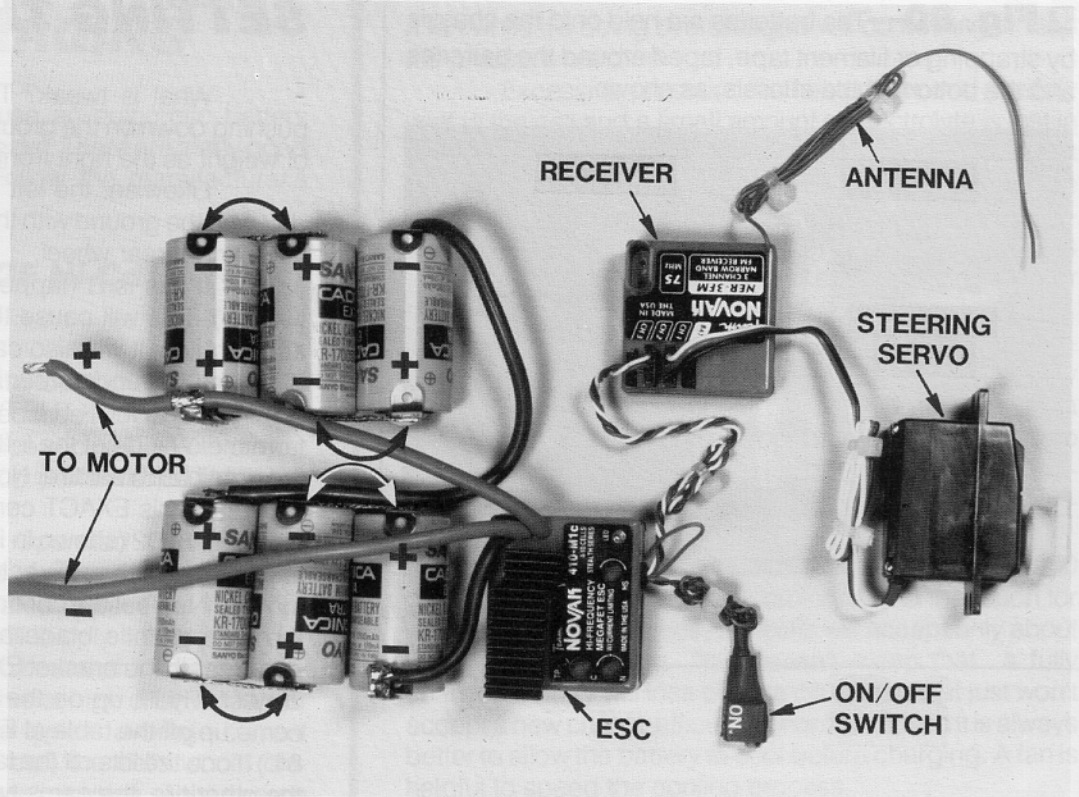

Fig. 78

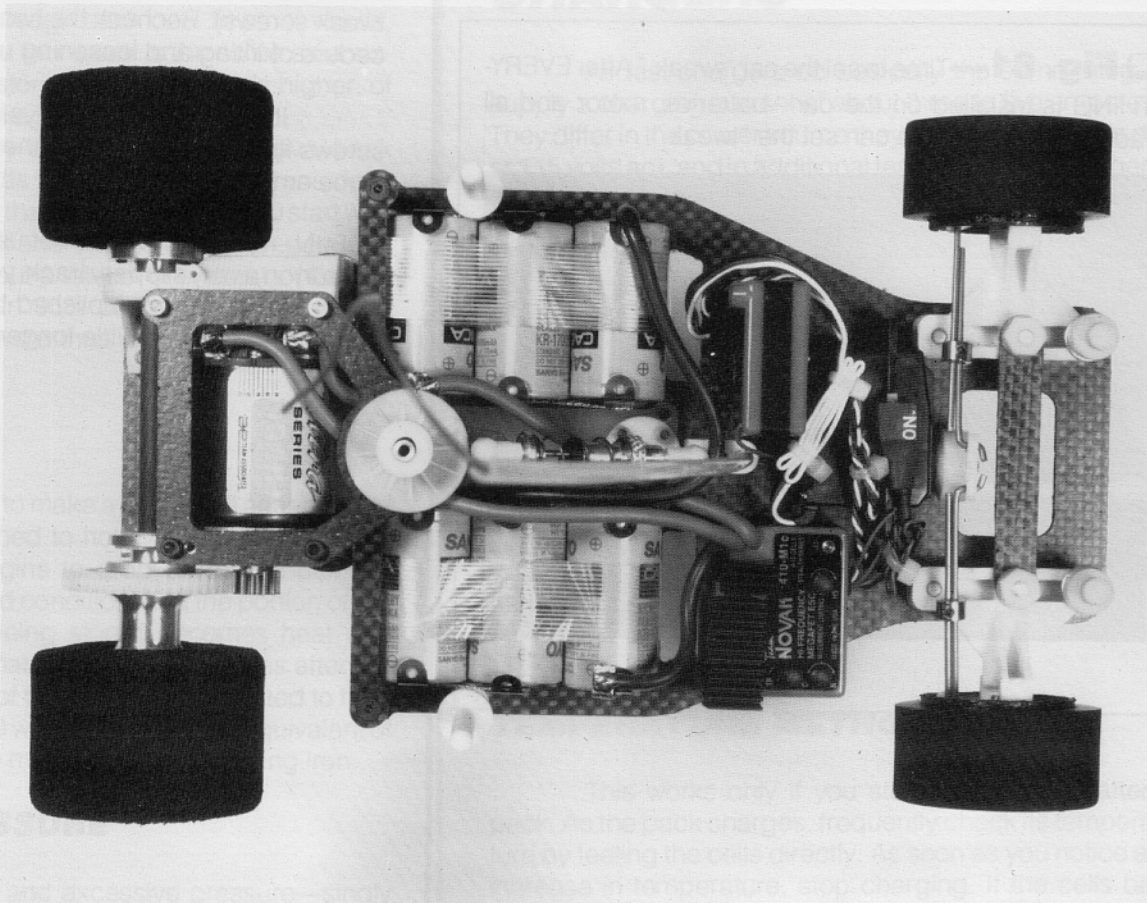

Fig. 79

□ **Fig. 80**—The batteries are held onto the chassis by strapping or filament tape, taped around the batteries and the bottom of the chassis, as shown.

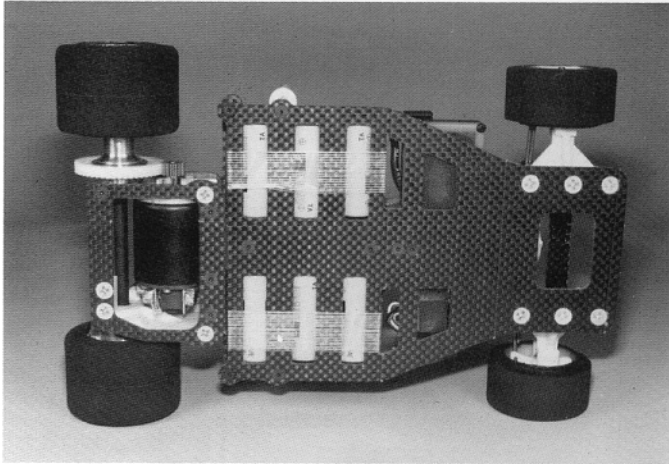

Fig. 80

□ **Fig. 81**—Time to set the car "tweak." After EVERYTHING is installed on the car—batteries, motor and all radio equipment—we can set the "tweak."

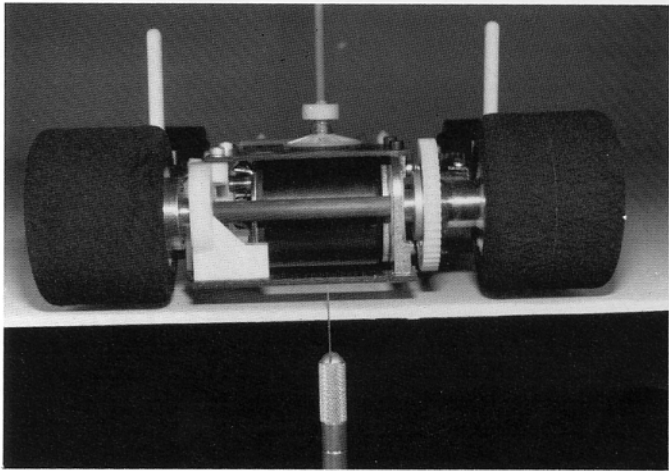

Fig. 81

SETTING THE TWEAK

What is tweak? The left front wheel should be pushing down on the ground with the exact same amount of weight as the right front wheel.

Likewise, the left rear wheel should be pushing down on the ground with the exact same amount of weight as the right rear wheel.

If this isn't happening, the car is TWEAKED (or twisted). This will cause the car to spin out easily under acceleration; it will also cause it to have oversteer in one direction and understeer in the other direction.

TO CHECK THE TWEAK, take a ruler and measure from the outside of the left hand rear tire to the outside of the right hand rear tire. Now take exactly half that amount and mark this EXACT centerline of the car on the lower bracket #8202 (shown in Fig. 81). Just scratch a mark on the bracket with an Exacto knife.

Now set the car on a very flat and level table. Take the Exacto knife blade and put the edge of the blade underneath the bracket EXACTLY where your mark is and very slowly lift up on the blade. BOTH rear tires should come up off the table at EXACTLY the same instant. (Fig. 81.) If one tire lifts off the table the slightest amount before the other tire, the car is tweaked.

TO CORRECT THE TWEAK, refer back to Fig. 16 and loosen one screw 1/8 of a turn (arrows point to the tweak screws). Recheck the tweak. Keep doing this procedure of lifting and loosening until the tweak is flat.

IMPORTANT— Always loosen one of the two screws first and then tighten the second screw the exact same amount.

TOE-IN—Normally, we do not use toe-in or toe-out. But if you run on a very slippery track, you might want to try some toe-in. Toe-in is accomplished by adjusting the tie rods (Fig. 76) so they're a little longer.

BATTERY CHARGING

We recommend you use an automatic battery charger like Novak and others make. There are many good brands on the market now. Follow the manufacturer's guidelines.

CHARACTERISTICS OF Ni-Cd BATTERIES

It is important to understand the characteristics of the battery pack in your car, because how you use it will greatly affect both its performance and its life. With proper care your pack will give you top performance for many hundreds of cycles.

The R.O.A.R.- (Radio Operated Auto Racing, Inc.) legal battery is composed of either four or six "sub-C" size cells with a maximum rated capacity of 1.2 amp-hrs. This means that the cells will supply 1.2 amperes for one hour, or 0.6 amperes for two hours, etc. This capacity rating drops to about 1.0 amp-hrs at high drain rates. For instance, at fifteen amperes (a typical average current drain for a 1/10 scale electric car) the cells would discharge in 1/12 of an hour (five minutes). This charge capacity is the same regardless of the number of cells in the pack because the cells are connected in series and the same current passes through each one. In other words, the charge capacity of a four-pack is the same as a six-pack. The total energy storage of a six-pack is higher, of course, because the voltage is higher.

Ni-Cds are very efficient and they give back almost as much charge as you put in, as long as you don't try to put in more charge than they will hold. If you start with a completely dead pack and charge at four amperes for 1/4 hour, you will have put a total of one amp-hr ($4 \times 1/4$) into the cells. More than 95% of the charge would be recovered if the pack were then discharged at the one hour rate.

OVERCHARGE

There is no way to make a Ni-Cd cell accept more charge than it is designed to hold. This means that the charging efficiency begins to drop off as the cell approaches a fully charged condition; and the portion of the charging current not being stored becomes heat and pressure. This means that if charging continues after the cell is fully charged, all of the current is converted to heat and pressure—about 40 watts worth—or the equivalent of the heat produced by a medium-sized soldering iron.

HEAT AND PRESSURE

Excessive heat and excessive pressure—singly or combined—is harmful to the cells; and getting rid of one won't offset the other. For example, cooling the battery with

a fan while it's being overcharged will do nothing to stop the pressure build-up.

Excessive pressure momentarily opens a safety vent in the cell and a small amount of electrolyte is lost in the process. One such occurrence is not harmful, but frequent venting will permanently reduce the performance of the cell. Excessively high temperatures can permanently damage the separators. High temperature also has temporary bad effects that will be explained later, under the heading, "High Temperature".

Ni-Cd cells have a built-in process for recombining the accumulated gas (actually oxygen) produced by overcharging, but the process produces heat and takes a lot of time. If you overcharge your battery and it seems to take a long time to cool down, it's because this pressure-reducing reaction is taking place. Once the gas is recombined, the temperature drops.

A hot Ni-Cd pack cannot be fully charged. At 130 degrees F (a temperature uncomfortable to the touch for more than a few seconds) the cells will accept only about 50% of a full charge. This doesn't mean that a fully charged battery will lose charge if it's heated; it just won't accept a new charge efficiently. For this reason it is always better to allow the battery to cool before charging. A fan is helpful to speed the cooling process.

CHARGERS

All fast-chargers do basically the same thing—supply a charging current of about three to five amperes. They differ in the power source they use (either 12 volts dc or 115 volts ac), and in additional features. Some chargers have features like a built-in voltmeter, constant-current, voltage peak detection, or temperature sensing. Naturally, the more features a charger has, the more expensive it becomes.

HOW TO TELL WHEN YOUR CELLS ARE CHARGED

One of the problems with Ni-Cds is their inherent voltage stability; the voltage of a fully charged cell is not much different from one that's about dead. For that reason several indicators, along with some common sense, are needed in order to get the most out of your battery. The following is a list of indicators you should use to detect full charge.

TEMPERATURE METHOD

This works only if you start with a cool battery pack. As the pack charges, frequently check its temperature by feeling the cells directly. As soon as you notice an increase in temperature, stop charging. If the cells become too hot to hold onto, your cells are excessively overcharged. Let them cool.

TIMED CHARGE METHOD

This works only if you have confidence in the timing accuracy of your charger. Many chargers on the market only approximate a constant charging current; they may vary from six amps when you first start charging, all the way down to two amps if the Ni-Cd pack is nearly charged and the voltage of the charging source (automobile battery) is low. If the charging current varies, it becomes difficult to estimate the average current. However, if your charger is reasonably dependable, you can use the following method.

Cycle your pack several times using the "temperature method" above. After you run the car the last time, let the pack cool. Charge again using the temperature method, but this time keep track of the time required to reach full charge. Once you have established the time, you can use it as a setting for the timer on your charger. To be safe, use a setting about a minute less than what you established. This method allows you to charge without constantly monitoring the battery temperature.

If you charge a battery that is still hot from running, reduce the time about 20%. Then, after the pack has cooled, finish charging with the temperature method.

VOLTAGE METHOD

As mentioned earlier, voltage is a poor indication of a cell's state of charge. The change in voltage from 10% charged to 100% charged is usually less than 0.1 volts per cell. In fact, other factors like temperature, current drain, and "cell memory" have a greater effect on voltage than the state of charge does. However, if current flow and temperature are held constant, it is possible to see the cell voltage gradually climb during the charging process. The absolute value of this voltage isn't of much use—how the voltage changes is an excellent indicator. To use this method, you will need a digital voltmeter or an expanded-scale voltmeter capable of resolving 0.01 volts on the 10 volt range.

Connect the voltmeter across the Ni-Cd pack, preferably right at the cell terminals, or, if that's not possible, across the terminals of the throttle control resistor. Don't try to read the voltage at the output of the charger because you'll end up reading the voltage drop through all the connectors and cables between the charger and the Ni-Cd pack, which can sometimes distort the effect you're looking for. You should start with a Ni-Cd pack that is less than half charged. Connect your charger and begin charging at four amps. If your charger is adjustable, set the current now—don't try to change it later. A constant current charger is preferable here, but if yours gradually drops off during charge, that's still permissible, as long as it doesn't drop below three amps.

Watch the voltage as the pack charges. Notice that the voltage at first climbs rapidly and in the middle of the charging cycle more slowly. This voltage will most

likely be in the range of 8 1/2 to 9 volts for a six cell pack. As the pack approaches full charge, the voltage will begin to climb more rapidly; and as it goes into overcharge, the climb will slow down and then stop. This is where you stop charging—at the point where the voltage stops climbing. If you left the charger on, the voltage would begin to fall as the pack went deeply into overcharge and started to heat up. The maximum voltage reached will probably be in the nine to ten volt region; the actual value is unimportant.

Don't try to use a conventional voltmeter. Even a good quality VOM with a large, taunt-band, mirrored-scale meter movement isn't adequate; by the time you could see that the voltage had stopped rising, it would be too late.

SLOW CHARGE METHOD

Slow or "overnight" charging is a method you are not likely to use often. However, it is a good way to bring the pack to absolutely full charge.

The charging current must be between 0.05 and 0.12 amperes. If less current, the pack will never reach full charge; any more and the pack will overheat. The time required to reach full charge ranges from 15 to 40 hours, depending on the current used. The charger can be left on for a much longer time without harming the cells, however, the output voltage of the pack will be temporarily lowered by an extremely long overcharge. The voltage returns to normal after a discharge-charge cycle.

GETTING MAXIMUM VOLTAGE TO THE MOTOR

The tips that follow are really for the benefit of serious racers, since these tips deal with factors that influence the voltage and available power of a Ni-Cd pack. We're talking about a difference of maybe 15% at the most, so if you're just out having fun, don't worry about it. Instead, skip ahead to the Radio section.

The output of a fully charged pack can vary considerably, depending on the temperature and recent activity of the pack. These effects are listed below.

HIGH TEMPERATURE contributes its bad effects by lowering the output voltage under load. Less voltage means less speed. At normal 130 degrees F, the voltage of a six cell pack can be almost a volt less than normal. Since a lot of heat is produced in the pack while the car is running, it's important to allow air to circulate around the batteries to keep them cool. Therefore, before the start of a race, keep your car out of the sun and off the hot asphalt.

MEMORY can also affect the output voltage. The first memory effect is caused by overcharging. The cells "remember" that they were overcharged and put out less voltage near the end of the discharge cycle. This is particularly noticeable if the pack is slow-charged for too

long a time.

The second memory effect is caused by repeatedly not using up all of the battery's stored charge before recharging. The cells "remember" that they weren't fully used and let the voltage drop off to about one volt at the point where discharge usually stops. An example would be where you run a series of five minute heats, recharging between each heat, and then try to run an eight minute heat. The battery voltage will be low for the last three minutes of the race. The cure is to fully discharge the pack before recharging. "Full discharge" means the point where the first cell goes dead. Never discharge beyond that point.

The third memory effect is the "topping-up" effect of recent charging. The cells remember that they were recently charged and will produce a little more voltage early in the discharge cycle. Racers take advantage of this by putting the last minute or two of charge into their pack just before the race starts.

GETTING MAXIMUM PERFORMANCE

FULL DISCHARGE. Ni-Cd packs perform best if they are completely discharged before they are charged. If you are involved in racing, you will have to do this if you expect to win any races! Various clip-on discharge resistors (about 30 ohms, 10 watts) are available at hobby stores. Discharge for at least an hour (preferably overnight with a clip-on resistor) before charging.

TOPPING-UP can give you a little extra voltage at the beginning of a race, as long as you don't overdo it. Put the last minute or two of charge into your pack just before the race starts.

YOUR RADIO

Now that you know all about batteries, go ahead and charge your batteries. After the car batteries are charged and the transmitter batteries are charged, we'll set the steering servo and speed control.

Now turn the transmitter on. Hold the rear tires off the ground and turn the receiver switch on. The motor may start to run, which means your speed control must be set. Whether the motor runs or not, **THE SPEED CONTROL MUST BE SET NOW.** Set it according to the manufacturer's recommendations. This is a very critical adjustment and will determine the car's top speed and battery life. Set it so there are no brakes. The car will have enough steering, so brakes are not used.

After the speed control is set, turn the receiver switch off.

Remove the steering servo saver from the servo. Turn the transmitter on and then the receiver switch on.

Push the Kimbrough servo saver back on and align it so that the wheels are pointing perfectly straight forward. Install the servo saver screw.

Turn the steering wheel to the right. With your car pointing away from you, the wheels should turn (steer) to the right. If they turn to the left, move the steering servo reversing switch on the transmitter.

YOUR MOTOR

Associated recommends the Reedy Modified motors. These motors have won seven IFMAR World Championships. No other motors have come close to this record. Check your RC12LW catalog for the various types of motors.

If you treat it properly, your motor will not only last much longer, but will run faster for a longer time too. So never let the brushes wear down too low. If they show signs of wearing, install new brushes. And never deliberately stall your motor. If your car is stuck in the wall, don't punch the throttle; you'll end up burning out your motor and speed control.

Reedy also makes a motor cleaner and motor lubricant—two excellent products vital for the care of your motor.

TRANSMITTER DUAL RATE

You should always turn the front wheels the **LEAST AMOUNT NECESSARY** to get around the track fast, not the most amount. So use the dual rate switch on your transmitter to give you the exact amount of steering you need and **NO MORE.**

YOUR BODY

MOUNT your body on the car while it is still clear so you can see through it to easily mark the body mount holes and antenna holes. The bottom of the body should be even with the chassis.

PAINT your body by masking off the inside of your body with regular automotive masking tape according to your paint scheme. Follow the tips that come with your Associated body you purchase separately. The best body paint to use is Pactra, available in all hobby stores.

YOUR WING

You probably won't need a wing if you run on carpet, but if you run on asphalt, try the car with and without a wing to see which works best on your track.

REZWA

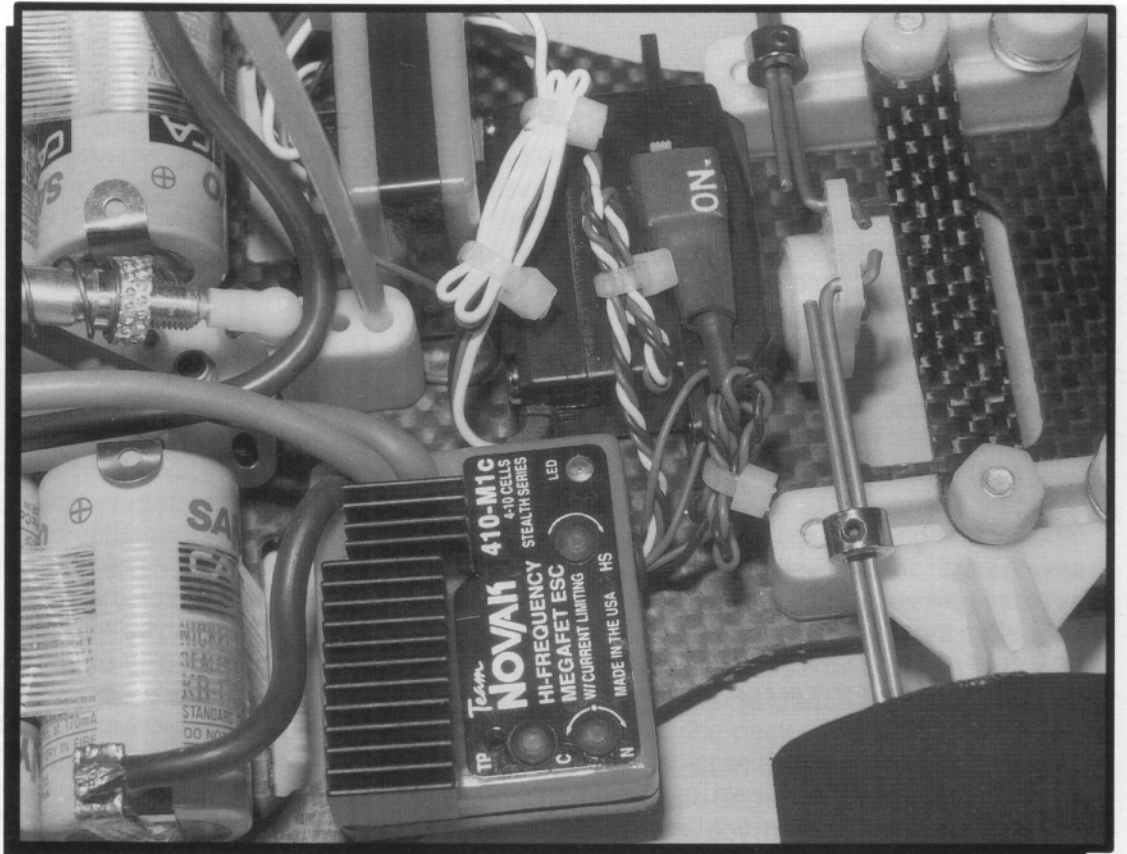

ASSOCIATED ELECTRICS, INC.
3585 CADILLAC AVENUE
COSTA MESA, CA 92626

TEAM ASSOCIATED 

